

Seria RS

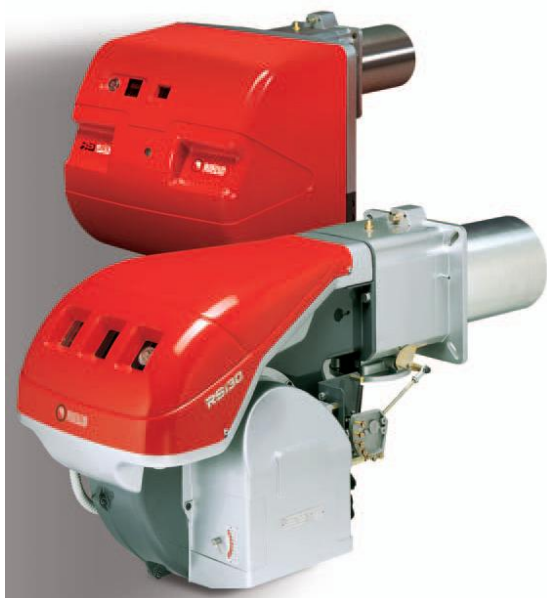

LUDOTERM

...Noi vă tratăm cu căldură

Arzătoarele din seria RS sunt arzătoare monobloc pe combustibil gazos, cu aer insuflat și funcționare în două trepte care au fost realizate pentru folosirea lor pe cazane de încălzire centrală cu apă caldă sau apă supraîncălzită, generatoare de aer cald sau pe cazane de abur. Sunt echipate cu tablou de comandă electronic cu auto-diagnoză: contorizează orele de funcționare, identifică cauza disfuncționalităților. Funcționează cu zgomot redus ca urmare a faptului că circuitul de aer este realizat din materiale fonoizolatoare. Seria RS acoperă o plajă de puteri cuprinsă între 81 – 2290 kW.

CARACTERISTICI CONSTRUCTIVE

- Complet automatizat
- Circuit de aspirație aer realizat din materiale fonoizolatoare
- Ventilator centrifugal de înaltă performanță cu emisii reduse de zgomot
- Temperatură de funcționare: max. 40°C
- Clapetă de reglare a debitului de aer și clapetă de reglare a debitului de gaz în treptele 1 și 2 acționate de un servomotor cu camă variabilă
- Clapetă de aer închisă complet în poziție de stand by pentru reducerea la minimum a pierderilor de energie din cazan
- Presostat de presiune minimă a aerului care comandă oprirea arzătorului în cazul disfuncționalităților ventilatorului
- Automat pentru controlul flăcării cu microprocesor și autodiagnoză
- Comutator manual pentru selectarea treptelor 1 sau 2
- Fereastră pentru inspecția flăcării
- Cap de ardere din oțel inox rezistent la temperaturi înalte care poate fi reglat în funcție de puterea termică necesară, echipat cu:
 - Cap de ardere conic
 - Electrozi de aprindere
 - Electrode de ionizare
 - Distribuitor de gaz
 - Disc stabilizator de flacără

- Rampă de gaz Multibloc:
 - Filtru
 - Stabilizator de presiune
 - Presostat de presiune minimă gaz
 - Electroventil de siguranță
 - Regulator de presiune
 - Ventil de reglaj

Diagrame alegere arzător

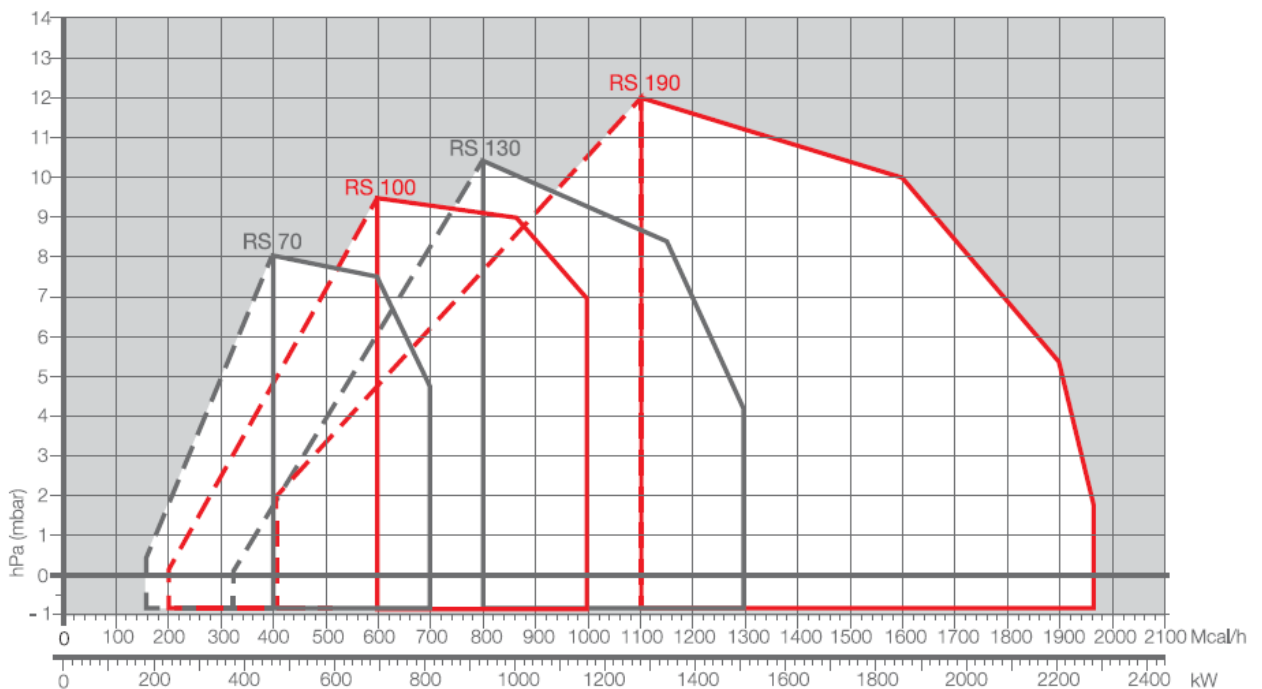
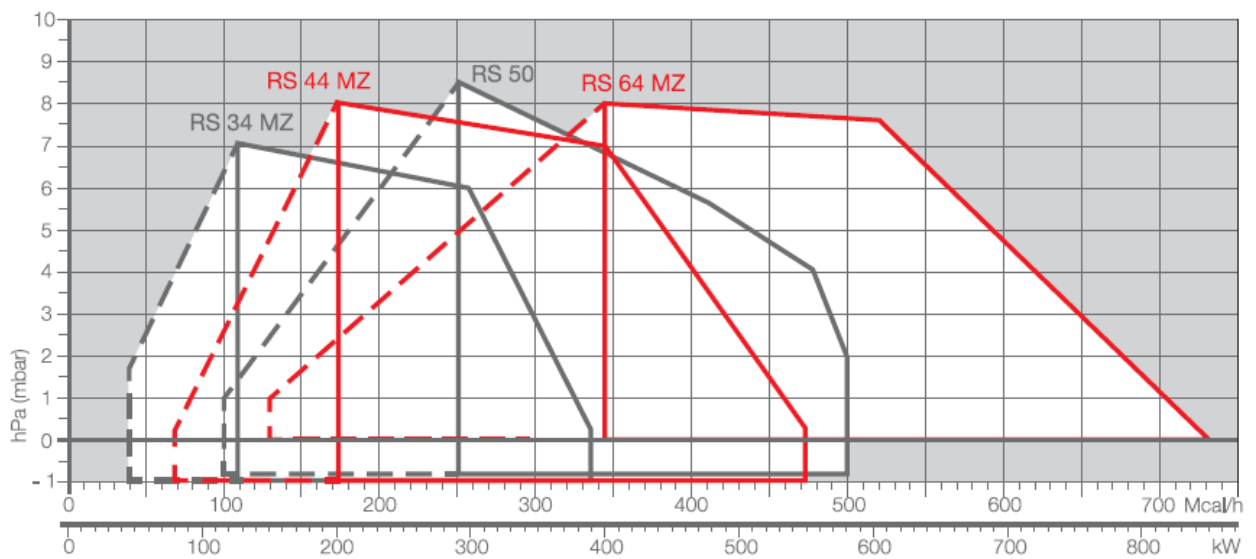

MODEL			RS 34 MZ	RS 44 MZ	RS 50	RS 64 MZ		
Cod Riello	Cap ardere standard		3789010	3789110	3784702	3789310		
	Cap ardere lung		3789011	3789111	3784703	3789311		
Putere termică	Tr. 2	kW	130 - 390	203 - 550	290 - 580	400 - 850		
	Tr. 1	kW	44	80	116	150		
Rampă gaz								
MBD 405 (GPL)	3/4"	3970500	MBD 405 (GPL)	3/4"	MBD 407 (GPL)	3/4"	MBD 407 (GPL)	3/4"
	Adaptor			3000824		Adaptor		3000824
MBD 407	3/4"	3970553	MBD 407	3/4"	MBD 410	1" - 3/4"	MBD 410 (GPL)	1" - 3/4"
	Adaptor			3000824		Adaptor		3000824
MBD 410	1" - 3/4"	3970554	MBD 410	1" - 3/4"	MBD 412	1 1/4"	MBD 412	1 1/4"
	Adaptor			3000824		Adaptor		3000824
MBD 412	1 1/4"	3970144	MBD 412	1 1/4"	MBD 412 CT	1 1/4"	MBD 412 CT	1 1/4"
	Adaptor			-		Adaptor		-
MBD 412 CT	1 1/4"	3970197	MBD 412 CT	1 1/4"	MBD 415	1 1/2"	MBD 415	1 1/2"
	Adaptor			-		Adaptor		-
MBD 415	1 1/2"	3970180	MBD 415	1 1/2"	MBD 415 CT	1 1/2"	MBD 415 CT	1 1/2"
	Adaptor			-		Adaptor		-
MBD 415 CT	1 1/2"	3970198	MBD 415 CT	1 1/2"	MBD 420	2"	MBD 420	2"
	Adaptor			-		Adaptor		-
MBD 420	2"	3970181	MBD 420	2"	MBD 420 CT	2"	MBD 420 CT	2"
	Adaptor			3000822		Adaptor		3000822
MBD 420 CT	2"	3970182	MBD 420 CT	2"	MBC1200 SE 50	2"	MBC1200 SE 50	2"
	Adaptor			3000822		Adaptor		3000822
					MBC1200 SE 50 CT	2"	MBC1200 SE 50 CT	2"
						Adaptor		3000822
Consum gaz metan	Tr. 2	Nm ³ /h	13 - 39	20,3 - 55	29 - 58		40 - 85	
	Tr. 1	Nm ³ /h	4,5	8,0	12		15	
Alimentare electrică			230V/50Hz			400V/50Hz		
Putere electrică totală		W	600	700	750		1200	
Nivel zgomot		dB	70	72	72		76	
Emisie NOx		mg/kWh	97	95	96		96,15	
Greutate		kg.	32	33	41		42	

MODEL			RS 70	RS 100	RS 130	RS 190				
Cod Riello	Cap ardere standard		3785102	3785302	3785502	3785813				
	Cap ardere lung		3785103	3785303	3785503	20030087				
Putere termică	Tr. 2	kW	465 - 814	698 - 1163	930 - 1512	1279 - 2290				
	Tr. 1	kW	192	232	372	470				
			Rampă gaz							
			MBD 412	1 1/4"	MBD 415	1 1/2"	MBD 415	1 1/2"	MBD 415 (GPL)	1 1/2"
				3970144		3970180		3970180		3970180
			Adaptor	3000843	Adaptor	3000843	Adaptor	3000843	Adaptor	3000843
			MBD 412 CT	1 1/4"	MBD 415 CT	1 1/2"	MBD 415 CT	1 1/2"	MBD 415 CT (GPL)	1 1/2"
				3970197		3970198		3970198		3970198
			Adaptor	3000843	Adaptor	3000843	Adaptor	3000843	Adaptor	3000843
			MBD 415	1 1/2"	MBD 420	2"	MBD 420	2"	MBD 420	2"
				3970180		3970181		3970181		3970181
			Adaptor	3000843	Adaptor	-	Adaptor	-	Adaptor	-
			MBD 415 CT	1 1/2"	MBD 420 CT	2"	MBD 420 CT	2"	MBD 420 CT	2"
				3970198		3970182		3970182		3970182
			Adaptor	3000843	Adaptor	-	Adaptor	-	Adaptor	-
			MBD 420	2"	MBC1200 SE 50	2"	MBC1200 SE 50	2"	MBC1200 SE 50	2"
				3970181		3970221		3970221		3970221
			Adaptor	-	Adaptor	-	Adaptor	-	Adaptor	-
			MBD 420 CT	2"	MBC1200 SE 50 CT	2"	MBC1200 SE 50 CT	2"	MBC1200 SE 50 CT	2"
				3970182		3970225		3970225		3970225
			Adaptor	-	Adaptor	-	Adaptor	-	Adaptor	-
			MBC1200 SE 50	2"	MBC 1900 SE 65 FC	DN 65	MBC 1900 SE 65 FC	DN 65	MBC 1900 SE 65 FC	DN 65
				3970221		3970222		3970222		3970222
			Adaptor	-	Adaptor	3000825	Adaptor	3000825	Adaptor	3000825
			MBC1200 SE 50 CT	2"	MBC 1900 SE 65 FC CT	DN 65	MBC 1900 SE 65 FC CT	DN 65	MBC 1900 SE 65 FC CT	DN 65
				3970225		3970226		3970226		3970226
			Adaptor	-	Adaptor	3000825	Adaptor	3000825	Adaptor	3000825
						MBC 3100 SE 80 FC	DN 65	MBC 3100 SE 80 FC	DN 80	
							3970223		3970223	
						Adaptor	3000826	Adaptor	3000826	
						MBC 3100 SE 80 FC CT	DN 65	MBC 3100 SE 80 FC CT	DN 80	
							3970227		3970227	
						Adaptor	3000826	Adaptor	3000826	
Consum gaz metan	Tr. 2	Nm ³ /h	46,5 - 81,4	69,8 - 116,3	93 - 151,2	129,9 - 229				
	Tr. 1	Nm ³ /h	19,2	23,2	37,2	47				
Alimentare electrică			400V/50Hz							
Putere electrică totală		W	1400	1800	2600	5500				
Nivel zgomot		dB	75	77	78,5	83				
Emisie NOx		mg/kWh	< 130							
Greutate		kg.	70	73	76	82				

Rampă de gaz

Rampă de gaz este livrată separat.

Presiunea maximă a gazului la intrarea în rampele de tip Multibloc este de 300 mbar, iar la cele de tip Compus este 500 mbar.

Dispozitivul de control al etanșeității, dacă nu este montat pe rampă, poate fi montat ulterior ca accesoriu.

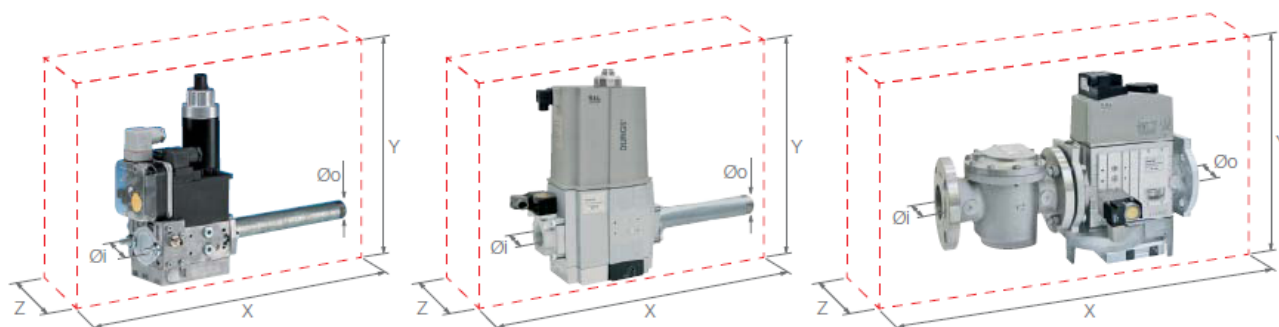

Rampă Multibloc
de tip MBD

Rampă Multibloc de
tip MBC 1200

Rampă Compusă de tip
MBC 1900 - 3100

	Rampă	Cod	ϕ_i	ϕ_o	X, mm	Y, mm	Z, mm	Pres. Gaz, mbar	Kit etanșitate
Rampă multibloc	MBD 405	3970500	3/4"	3/4"	371	186	120	4 - 20	Accesoriu
	MBD 407	3970553	3/4"	3/4"	371	196	120	4 - 20	Accesoriu
	MBD 410	3970554	1"	3/4"	405	217	145	4 - 20	Accesoriu
	MBD 412	3970144	1 1/4"	1 1/4"	433	217	145	4 - 20	Accesoriu
	MBD 412 CT	3970197	1 1/4"	1 1/4"	433	217	262	4 - 20	Incorporat
	MBD 415	3970180	1 1/2"	1 1/2"	523	250	100	4 - 33	Accesoriu
	MBD 415 CT	3970198	1 1/2"	1 1/2"	523	250		4 - 33	Incorporat
	MBD 420	3970181	2"	2"	523	300		4 - 33	Accesoriu
	MBD 420 CT	3970182	2"	2"	523	300	227	4 - 33	Incorporat
	MBC 1200 SE 50	3970221	2"	2"	523	425	161	4 - 60	Accesoriu
	MBC 1200 SE 50 CT	3970225	2"	2"	523	425	288	4 - 60	Incorporat
Rampă compusă	MBC 1900 SE 65 FC	3970222	DN 65	DN 65	583	430	237	20 - 40	Accesoriu
	MBC 1900 SE 65 FC CT	3970226	DN 65	DN 65	583	430	364	20 - 40	Incorporat
	MBC 3100 SE 80 FC	3970223	DN 80	DN 80	633	500	240	20 - 40	Accesoriu
	MBC 3100 SE 80 FC CT	3970227	DN 80	DN 80	633	500	367	20 - 40	Incorporat

Diagrame alegere rampă

RS 34 MZ (NATURAL GAS)

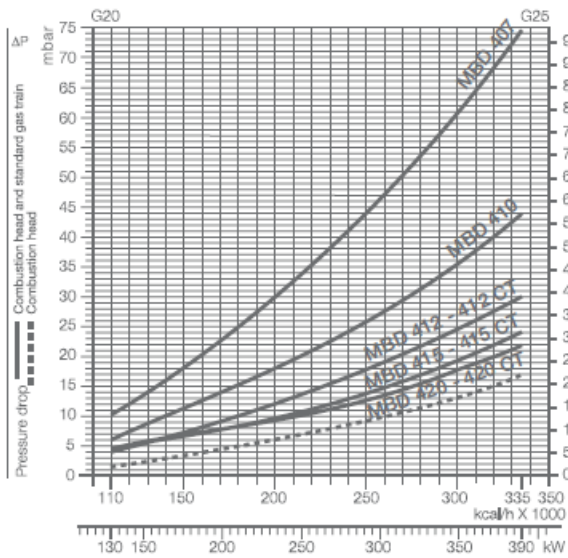

RS 34 MZ (LPG)

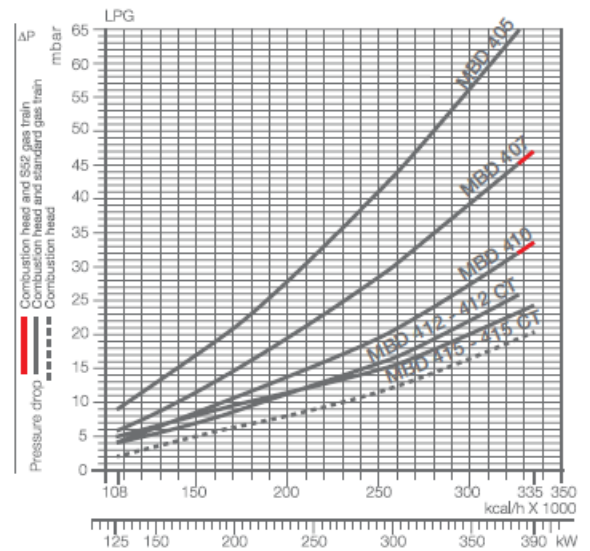

Rampă	Gaz metan		GPL		Kit etanșitate
	Cod rampă	Adaptor	Cod rampă	Adaptor	
MBD 405	-	-	3970500	3000824	Accesoriu
MBD 407	3970553	3000824	3970553	3000824	Accesoriu
MBD 410	3970554	3000824	397554	3000824	Accesoriu
MBD 412	3970144	-	3970144	-	Accesoriu
MBD 412 CT	3970197	-	3970197	-	Incorporat
MBD 415	3970180	-	3970180	-	Accesoriu
MBD 415 CT	3970198	-	3970198	-	Incorporat
MBD 420	3970181	3000822	-	-	Accesoriu
MBD 420 CT	3970182	3000822	-	-	Incorporat

RS 44 MZ (NATURAL GAS)

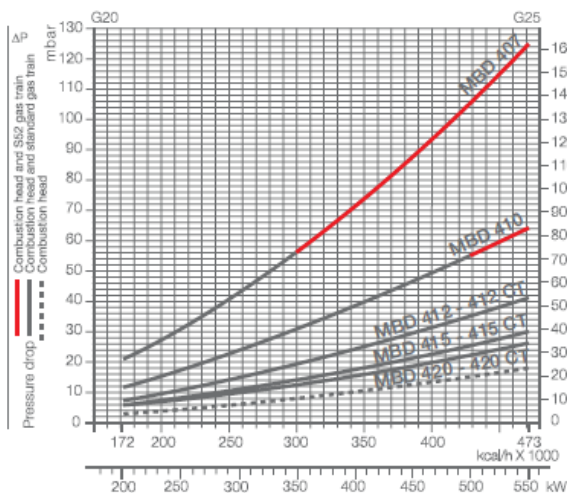

RS 44 MZ (LPG)

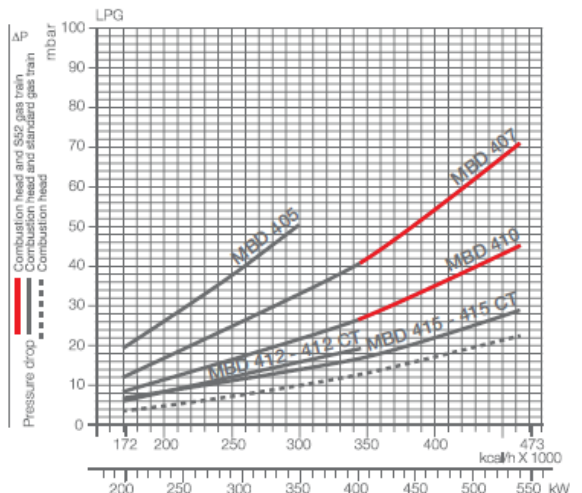

Rampă	Gaz metan		GPL		Kit etanșeitate
	Cod rampă	Adaptor	Cod rampă	Adaptor	
MBD 405	-	-	3970500	3000824	Accesoriu
MBD 407	3970553	3000824	3970553	3000824	Accesoriu
MBD 410	3970554	3000824	397554	3000824	Accesoriu
MBD 412	3970144	-	3970144	-	Accesoriu
MBD 412 CT	3970197	-	3970197	-	Incorporat
MBD 415	3970180	-	3970180	-	Accesoriu
MBD 415 CT	3970198	-	3970198	-	Incorporat
MBD 420	3970181	3000822	-	-	Accesoriu
MBD 420 CT	3970182	3000822	-	-	Incorporat

RS 50 (NATURAL GAS)

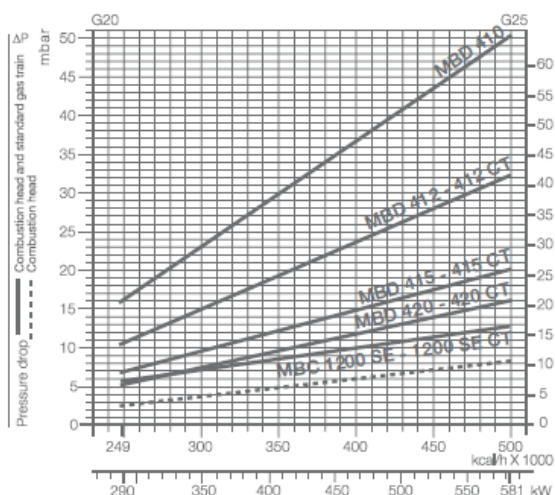

RS 50 (LPG)

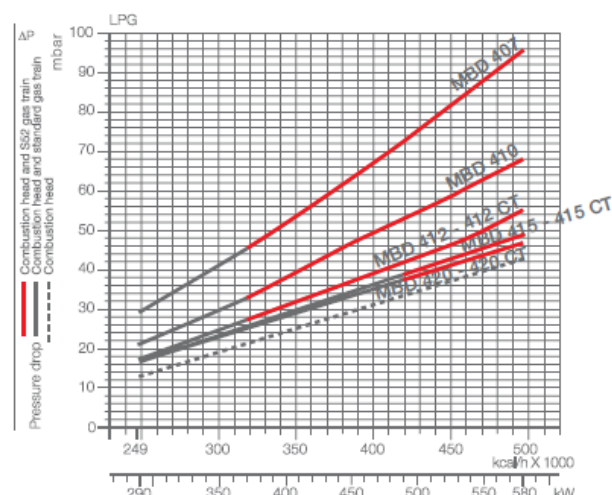

Rampă	Gaz metan		GPL		Kit etanșeitate
	Cod rampă	Adaptor	Cod rampă	Adaptor	
MBD 407	-	-	3970553	3000824	Accesoriu
MBD 410	3970554	3000824	397554	3000824	Accesoriu
MBD 412	3970144	-	3970144	-	Accesoriu
MBD 412 CT	3970197	-	3970197	-	Incorporat
MBD 415	3970180	-	3970180	-	Accesoriu
MBD 415 CT	3970198	-	3970198	-	Incorporat
MBD 420	3970181	3000822	3970181	3000822	Accesoriu
MBD 420 CT	3970182	3000822	3970182	3000822	Incorporat
MBC 1200 SE 50	3970221	3000822	-	-	Accesoriu
MBC 1200 SE 50 CT	3970225	3000822	-	-	Incorporat

RS 64 MZ (NATURAL GAS)

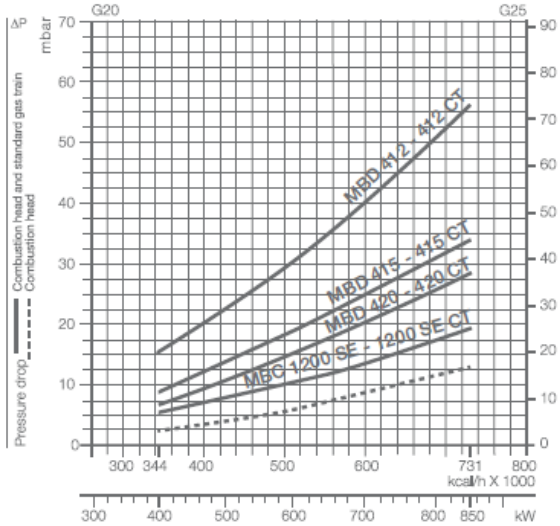

RS 64 MZ (LPG)

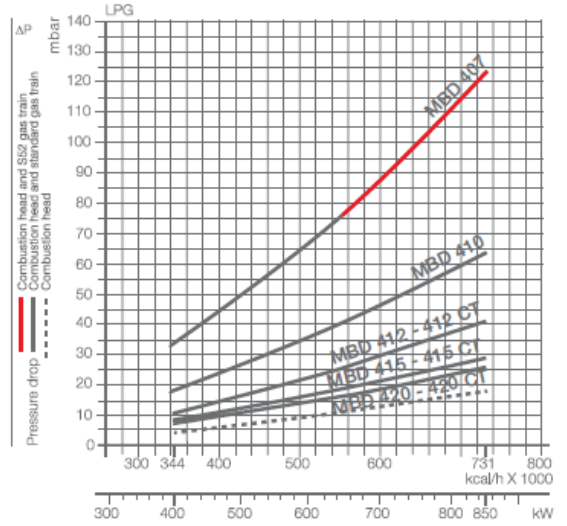

Rampă	Gaz metan		GPL		Kit etanșeitate
	Cod rampă	Adaptor	Cod rampă	Adaptor	
MBD 407	-	-	3970553	3000824 + 3000843	Accesoriu
MBD 410	-	-	397554	3000824 + 3000843	Accesoriu
MBD 412	3970144	3000843	3970144	3000843	Accesoriu
MBD 412 CT	3970197	3000843	3970197	3000843	Incorporat
MBD 415	3970180	3000843	3970180	3000843	Accesoriu
MBD 415 CT	3970198	3000843	3970198	3000843	Incorporat
MBD 420	3970181	-	3970181	-	Accesoriu
MBD 420 CT	3970182	-	3970182	-	Incorporat
MBC 1200 SE 50	3970221	-	-	-	Accesoriu
MBC 1200 SE 50 CT	3970225	-	-	-	Incorporat

RS 70 (NATURAL GAS)

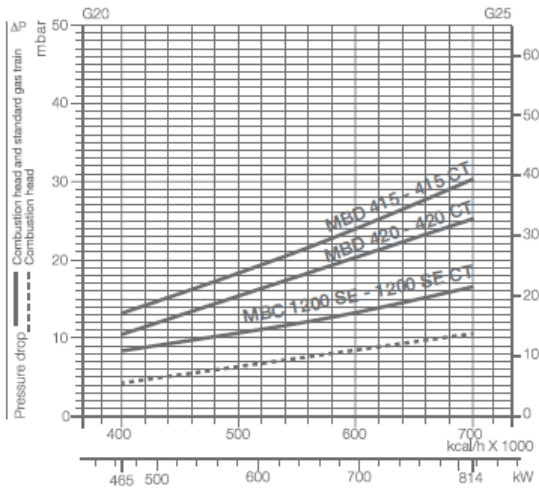

RS 70 (LPG)

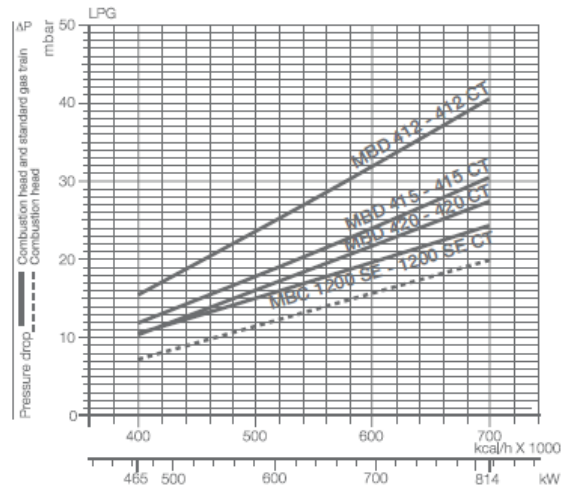

Rampă	Gaz metan		GPL		Kit etanșeitate
	Cod rampă	Adaptor	Cod rampă	Adaptor	
MBD 412	-	-	3970144	3000843	Accesoriu
MBD 412 CT	-	-	3970197	3000843	Incorporat
MBD 415	3970180	3000843	3970180	3000843	Accesoriu
MBD 415 CT	3970198	3000843	3970198	3000843	Incorporat
MBD 420	3970181	-	3970181	-	Accesoriu
MBD 420 CT	3970182	-	3970182	-	Incorporat
MBC 1200 SE 50	3970221	-	3970221	-	Accesoriu
MBC 1200 SE 50 CT	3970225	-	3970225	-	Incorporat

RS 100 (NATURAL GAS)

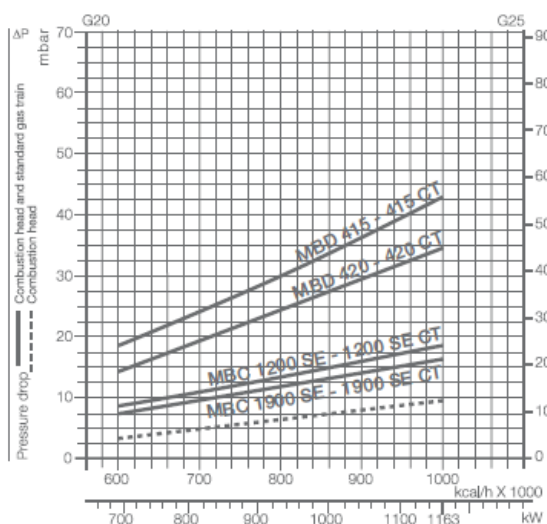

RS 100 (LPG)

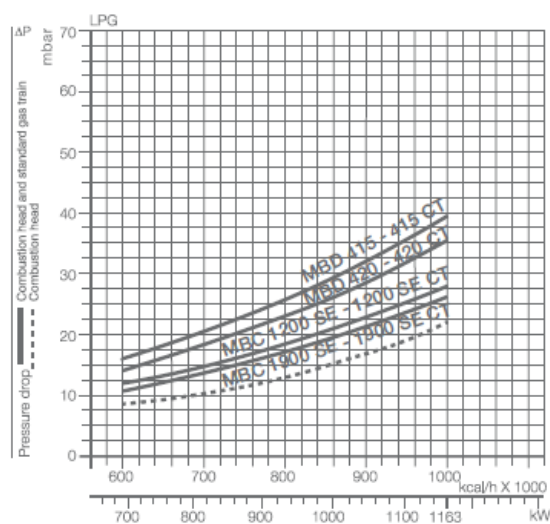

Rampă	Gaz metan		GPL		Kit etanșeitate
	Cod rampă	Adaptor	Cod rampă	Adaptor	
MBD 415	3970180	3000843	3970180	3000843	Accesoriu
MBD 415 CT	3970198	3000843	3970198	3000843	Incorporat
MBD 420	3970181	-	3970181	-	Accesoriu
MBD 420 CT	3970182	-	3970182	-	Incorporat
MBC 1200 SE 50	3970221	-	3970221	-	Accesoriu
MBC 1200 SE 50 CT	3970225	-	3970225	-	Incorporat
MBC 1900 SE 65 FC	3970222	3000825	3970222	3000825	Accesoriu
MBC 1900 SE 65 FC CT	3970226	3000825	3970226	3000825	Incorporat

RS 130 (NATURAL GAS)

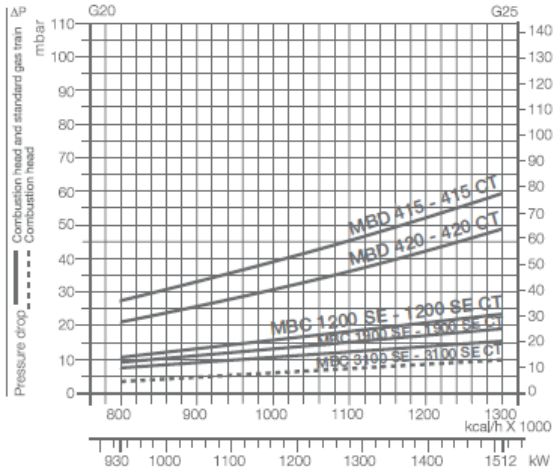

RS 130 (LPG)

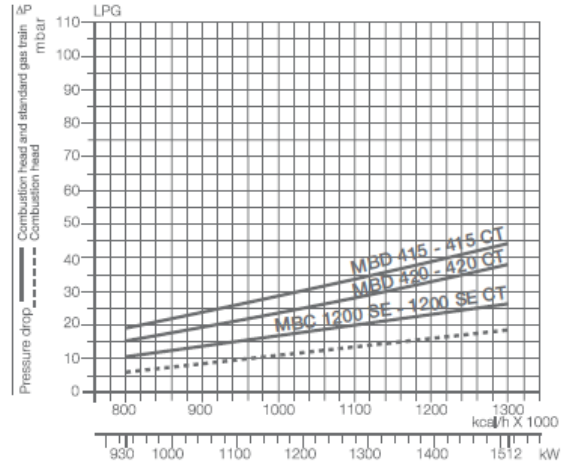

Rampă	Gaz metan		GPL		Kit etanșeitate
	Cod rampă	Adaptor	Cod rampă	Adaptor	
MBD 415	3970180	3000843	3970180	3000843	Accesoriu
MBD 415 CT	3970198	3000843	3970198	3000843	Incorporat
MBD 420	3970181	-	3970181	-	Accesoriu
MBD 420 CT	3970182	-	3970182	-	Incorporat
MBC 1200 SE 50	3970221	-	3970221	-	Accesoriu
MBC 1200 SE 50 CT	3970225	-	3970225	-	Incorporat
MBC 1900 SE 65 FC	3970222	3000825	3970222	3000825	Accesoriu
MBC 1900 SE 65 FC CT	3970226	3000825	3970226	3000825	Incorporat
MBC 3100 SE 80 FC	3970223	3000826	-	-	Accesoriu
MBC 3100 SE 80 FC CT	3970227	3000826	-	-	Incorporat

RS 190 (NATURAL GAS)

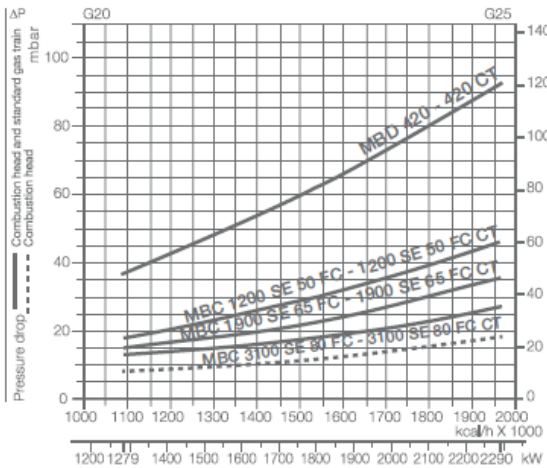

RS 190 (LPG)

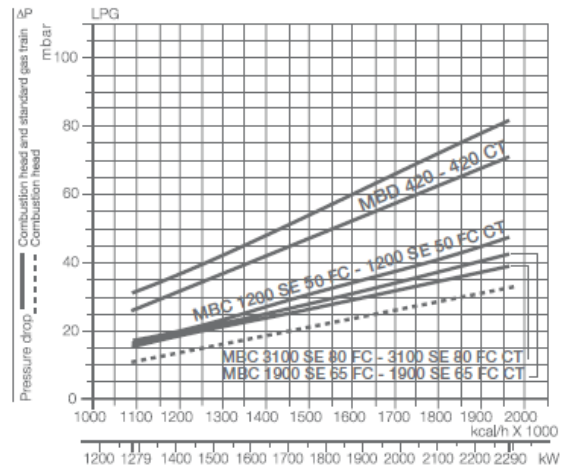

Rampă	Gaz metan		GPL		Kit etanșeitate
	Cod rampă	Adaptor	Cod rampă	Adaptor	
MBD 415	-	-	3970180	3000843	Accesoriu
MBD 415 CT	-	-	3970198	3000843	Incorporat
MBD 420	3970181	-	3970181	-	Accesoriu
MBD 420 CT	3970182	-	3970182	-	Incorporat
MBC 1200 SE 50	3970221	-	3970221	-	Accesoriu
MBC 1200 SE 50 CT	3970225	-	3970225	-	Incorporat
MBC 1900 SE 65 FC	3970222	3000825	3970222	3000825	Accesoriu
MBC 1900 SE 65 FC CT	3970226	3000825	3970226	3000825	Incorporat
MBC 3100 SE 80 FC	3970223	3000826	3970223	3000826	Accesoriu
MBC 3100 SE 80 FC CT	3970227	3000826	3970227	3000826	Incorporat

Dimensiuni

RS 34 MZ - 44 MZ

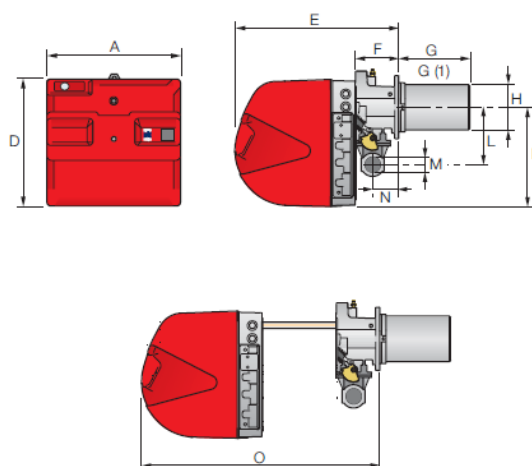

RS 50

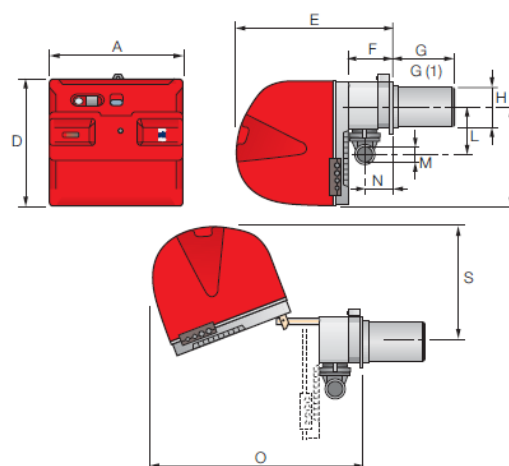

MODEL	A	D	E	F	G - G(1)	H	I	L	M	N	O	S
► RS 34 MZ	442	422	508	138	216 - 351	140	305	177	1"1/2	84	780	-
► RS 44 MZ	442	422	508	138	216 - 351	152	305	177	1"1/2	84	780	-
► RS 50	476	474	580	164	216 - 351	152	352	168	1"1/2	108	810	367

(1) Cu cap de ardere lung

RS 64 MZ

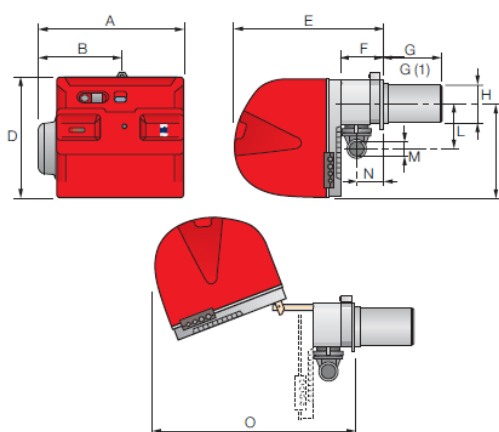

RS 70 - 100 - 130 - 190

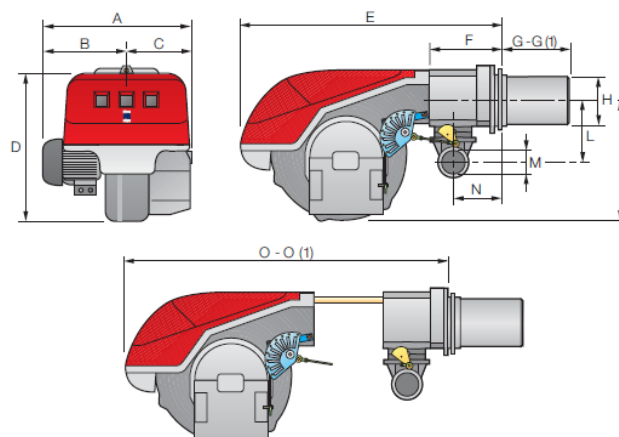

MODEL	A	B	C	D	E	F	G - G(1)	H	I	L	M	N	O - O(1)
▶ RS 64 MZ	533	300	-	490	640	222	250 - 385	179	352	221	2"	134	810 - -
▶ RS 70	511	296	215	555	840	214	250 - 385	179	430	221	2"	134	1161 - 1296
▶ RS 100	527	312	215	555	840	214	250 - 385	179	430	221	2"	134	1161 - 1296
▶ RS 130	553	338	215	555	840	214	280 - 415	189	430	221	2"	134	1161 - 1296
▶ RS 190	681	366	315	555	856	230	372 - 530	222	430	221	2"	150	1312 - -

(1) Cu cap de ardere lung

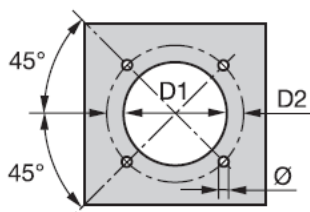

MODEL	D1	D2	Ø
▶ RS 34 MZ	160	224	M8
▶ RS 44 MZ	160	224	M8
▶ RS 50	160	224	M8
▶ RS 64 MZ	185	275-325	M12
▶ RS 70	185	275-325	M12
▶ RS 100	185	275-325	M12
▶ RS 130	195	275-325	M12
▶ RS 190	230	325-368	M16

Accesorii

Cap de ardere lung

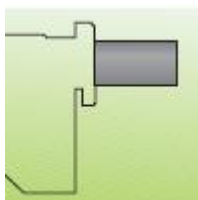

Arzător	Cap ardere standard, mm	Cap ardere lung	
		mm	Cod
RS 34 MZ	216	351	3010428
RS 44 MZ	216	351	3010429
RS 50	216	351	3010078
RS 64 MZ	250	385	3010427
RS 70	250	385	3010117
RS 100	250	385	3010118
RS 130	280	415	3010119
RS 190	372	530	3010443

Kit de ventilație continuă

În cazul în care este necesară ventilația arzătorului în perioadele în care nu funcționează se folosește kit-ul din tabelul următor:



Arzător	Cod Kit
RS 34 MZ - RS 44 MZ	3010449
RS 50 - RS 64 MZ - RD 70 - RS 100 - RS 130 - RS 190	3010094

Kit GPL



Arzător	Cod Kit GPL	
	Cap de ardere standard	Cap de ardere lung
RS 34 MZ	3010423	3010423
RS 44 MZ	3010424	3010424
RS 50	20008173	20008173
RS 64 MZ	3010434	3010435
RS 70	20008175	20008176
RS 100	20008177	20008178
RS 130	20008179	20008180
RS 190	3010166	3010166































Kit de reducere a vibrațiilor



Arzător	Cod kit
RS 50 TC - RS 50 TL	3010200
RS 70 TC - RS 70 TL	3010201
RS 100 TC - RS 100 TL	3010202
RS 130 TC	3010373
RS 100 TL	3010374
RS 190 TC	3010375

Adaptoare

Se folosesc atunci când diametrul rampei de gaz diferă de racordul arzătorului. În tabelul de mai jos sunt indicate tipurile de adaptoare corelate cu rampele arzătoarelor.

ARZĂTOR	RAMPĂ	DIMENSIUNI	COD ADAPTOR
▶ RS 34 MZ	MBD 405 - 407 - 410	3/4"  1 1/2"	3000824
	MBD 420	2"  1 1/2"	3000822
▶ RS 44 MZ	MBD 405 - 407 - 410	3/4"  1 1/2"	3000824
	MBD 420	2"  1 1/2"	3000822
▶ RS 50	MBD 407 - 410	3/4"  1 1/2"	3000824
	MBD 420 - MBC 1200	2"  1 1/2"	3000822
▶ RS 64 MZ	MBD 407 - 410	3/4"  1 1/2"	3000824
		1 1/2"  2"	+ 3000843
	MBD 412 - 415	1 1/2"  2"	3000843
▶ RS 70	MBD 410	3/4"  1 1/2"	3000824
		1 1/2"  2"	+ 3000843
	MBD 412 - 415	1 1/2"  2"	3000843
	MBC 1900	DN 65  2 1/2"  1 1/2"  2"	3000825
MBC 3100	DN 80  2 1/2"  2"	3000826	
▶ RS 100	MBD 410	3/4"  1 1/2"	3000824
		1 1/2"  2"	+ 3000843
	MBD 415	1 1/2"  2"	3000843
	MBC 1900	DN 65  2 1/2"  1 1/2"  2"	3000825
MBC 3100	DN 80  2 1/2"  2"	3000826	
▶ RS 130	MBD 415	1 1/2"  2"	3000843
	MBC 1900	DN 65  2 1/2"  1 1/2"  2"	3000825
	MBC 3100	DN 80  2 1/2"  2"	3000826

ARZĂTOR	RAMPĂ	DIMENSIUNI	COD ADAPTOR
▶ RS 190	MBD 415	1 1/2"  2"	3000843
	MBC 1900	DN 65  2 1/2"  1 1/2"  2"	3000825
	MBC 3100	DN 80  2 1/2"  2"	3000826

Kit de control al etanșeității

Este disponibil un kit special care controlează etanșeitățile rampei de gaz. Kit-ul de control al etanșeității este obligatoriu (EN 676) în cazul arzătoarelor cu puteri maxime de peste 1200 kW. Kit-ul este de tip VPS 504.



Rampa de gaz	Cod Kit
Tip MBD	3010123
Tip MBC	3010367