

Seria RS/M

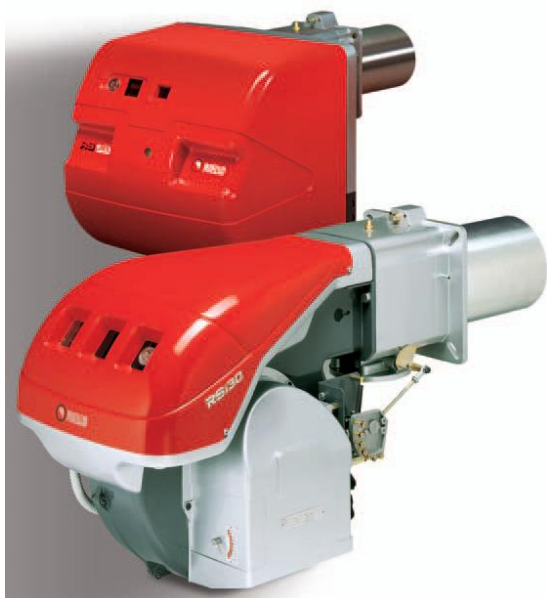

LUDOTERM

...Noi vă tratăm cu căldură

Arzătoarele din seria RS/M sunt arzătoare pe combustibil gazos, cu funcționare în două trepte progresive sau modulante (cu kit de modularizare), cu aer insuflat care au fost realizate pentru folosirea lor pe cazane de încălzire centrală cu apă caldă sau apă supraîncălzită, generatoare de aer cald sau pe cazane de abur. Sunt echipate cu tablou de comandă electronic cu auto-diagnoză: contorizează orele de funcționare, identifică cauza disfuncționalităților. Funcționează cu zgomot redus ca urmare a faptului că ventilatorul are pale înclinate către înaintea iar circuitul de aer este realizat cu materiale reducătoare de zgomot. Seria RS acoperă o plajă de puteri cuprinsă între 81 – 2290 kW.

CARACTERISTICI CONSTRUCTIVE

- Complet automatizat
- Temperatură de funcționare: max. 40°C
- Pentru funcționarea în regim modulante este necesar kitul RWF 40
- Clapetă de aer cu servomotor
- Clapetă de aer închisă complet în poziție de stand by pentru reducerea la minimum a pierderilor de energie din cazan
- Presostat de aer care comandă oprirea arzătorului în cazul disfuncționalităților ventilatorului
- Tablou de comandă pentru controlul flăcării
- Întrerupător manual pentru oprirea treptelor 1 sau 2
- Fereastră pentru inspecția flăcării
- Ventilator centrifugal cu pale înclinate către înaintea cu emisii reduse de zgomot
- Cap de ardere din oțel inox rezistent la temperaturi înalte
 - Cap de ardere conic
 - Electrozi de aprindere
 - Electrode de ionizare
 - Distribuitor de gaz
 - Disc stabilizator de flacără
- Rampă de gaz Multibloc:
 - Filtru
 - Stabilizator de presiune
 - Presostat de presiune minimă gaz
 - Ventil de siguranță
 - Regulator de presiune
 - Ventil de reglaj

Diagrame alegere arzător

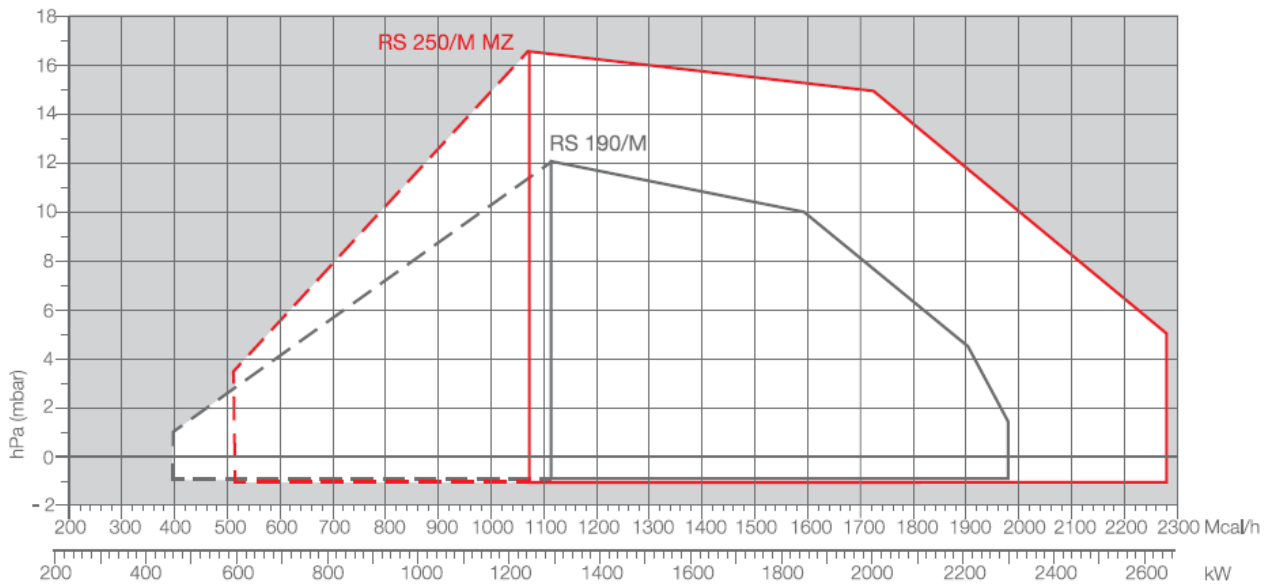
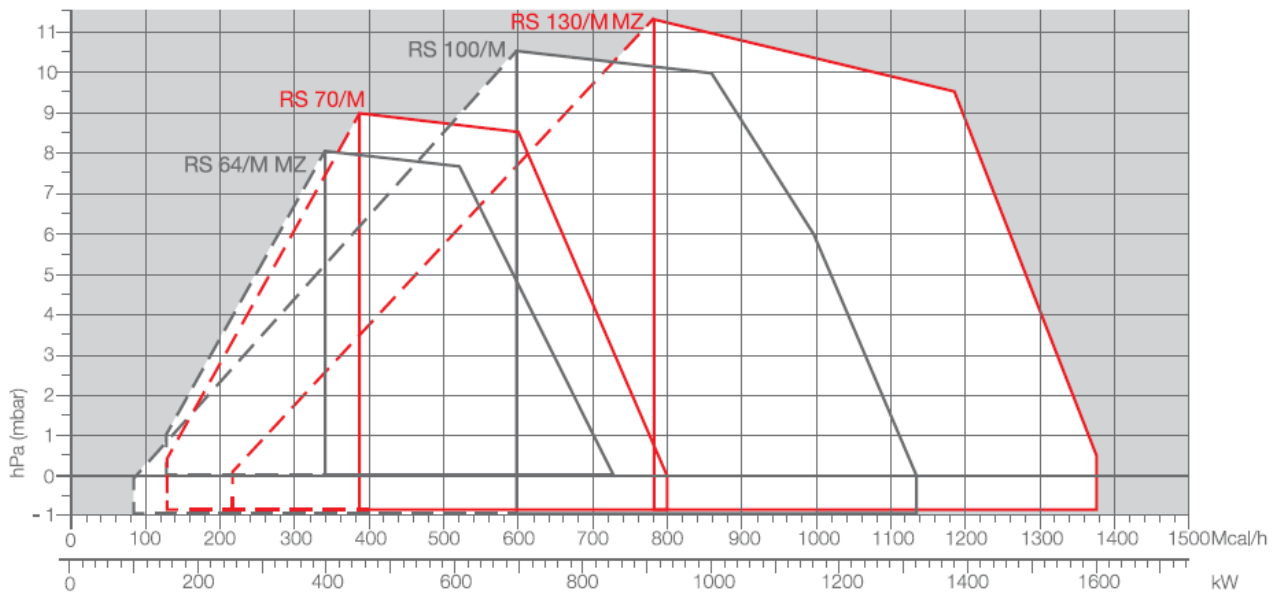
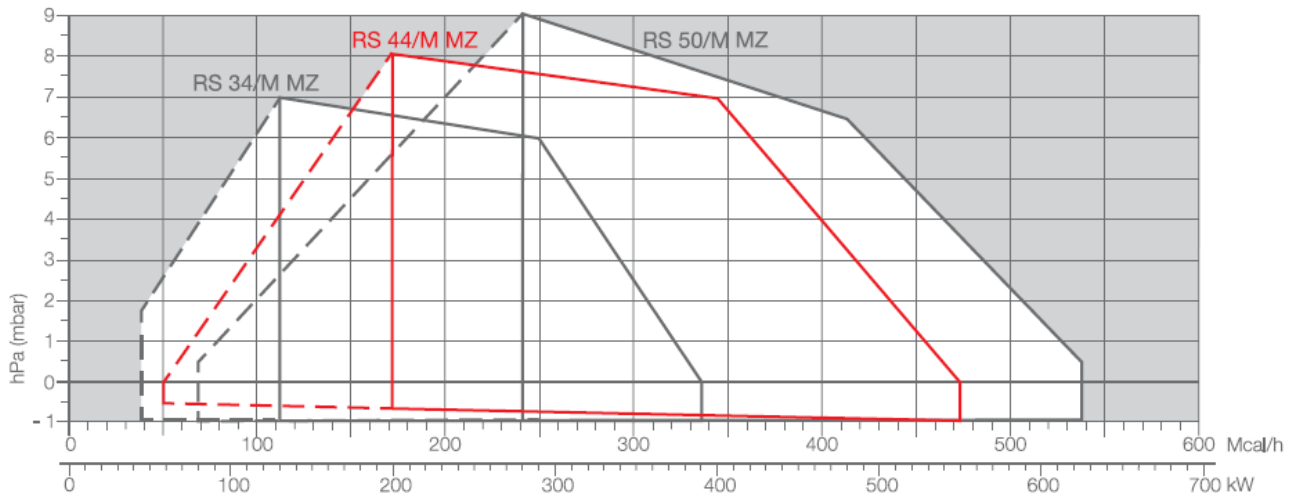

MODEL			RS 34/M MZ	RS 44/M MZ	RS 50/M MZ	RS 64/M MZ				
Cod Riello	Cap ardere standard		3788710	3788810	3781622	3788910				
	Cap ardere lung		3788711	3788811	3781623	3788911				
Putere termică	Tr. 2	kW	125 - 390	203 - 550	285 - 630	400 - 850				
	Tr. 1	kW	45	80	80	150				
			Rampă gaz							
			MBD 405 (GPL)	3/4"	MBD 405 (GPL)	3/4"	MBD 410	1" - 3/4"	MBD 412	1 1/4"
				3970500		3970500		3970554		3970144
			Adaptor	3000824	Adaptor	3000824	Adaptor	3000824	Adaptor	3000843
			MBD 407	3/4"	MBD 407 (GPL)	3/4"	MBD 412	1 1/4"	MBD 412 CT	1 1/4"
				3970553		3970553		3970144		3970197
			Adaptor	3000824	Adaptor	3000824	Adaptor	-	Adaptor	3000843
			MBD 410	1" - 3/4"	MBD 410	1" - 3/4"	MBD 412 CT	1 1/4"	MBD 415	1 1/2"
				3970554		3970554		3970197		3970180
			Adaptor	3000824	Adaptor	3000824	Adaptor	-	Adaptor	3000843
			MBD 412	1 1/4"	MBD 412	1 1/4"	MBD 415	1 1/2"	MBD 415 CT	1 1/2"
				3970144		3970144		3970180		3970198
			Adaptor	-	Adaptor	-	Adaptor	-	Adaptor	3000843
			MBD 412 CT	1 1/4"	MBD 412 CT	1 1/4"	MBD 415 CT	1 1/2"	MBD 420	2"
				3970197		3970197		3970198		3970181
			Adaptor	-	Adaptor	-	Adaptor	-	Adaptor	-
			MBD 415	1 1/2"	MBD 415	1 1/2"	MBD 420	2"	MBD 420 CT	2"
				3970180		3970180		3970181		3970182
			Adaptor	-	Adaptor	-	Adaptor	3000822	Adaptor	-
			MBD 415 CT	1 1/2"	MBD 415 CT	1 1/2"	MBD 420 CT	2"	MBC1200 SE 50	2"
				3970198		3970198		3970182		3970221
			Adaptor	-	Adaptor	-	Adaptor	3000822	Adaptor	-
			MBD 420	2"	MBD 420	2"	MBC1200 SE 50	2"	MBC1200 SE 50 CT	2"
				3970181		3970181		3970221		3970225
			Adaptor	3000822	Adaptor	3000822	Adaptor	3000822	Adaptor	-
			MBD 420 CT	2"	MBD 420 CT	2"	MBC1200 SE 50 CT	2"		
				3970182		3970182		3970225		
			Adaptor	3000822	Adaptor	3000822	Adaptor	3000822		
Consum gaz metan	Tr. 2	Nm ³ /h	12,5 - 39	20,3 - 55	28,5 - 63	40 - 85				
	Tr. 1	Nm ³ /h	4,5	8	8	15				
Alimentare electrică			230V/50Hz		400V/50Hz					
Putere electrică totală		W	600	700	750	1400				
Nivel zgomot		dB	70	72	72	76				
Emisie NOx		mg/kWh	97	95	96	96,15				
Greutate		kg.	32	33	41	42				

MODEL			RS 70	RS 100	RS 130	RS 190			
Cod Riello	Cap ardere standard		3789610	3789710	3789810	3787623			
	Cap ardere lung		3789611	3789711	3789811	-			
Putere termică	Tr. 2	kW	470 - 930	700 - 1340	920 - 1600	1279 - 2290			
	Tr. 1	kW	150	150	240	470			
			Rampă gaz						
			MBD 412 (GPL)	1 1/4"	MBD 415	1 1/2"	MBD 415 (GPL)	1 1/2"	
				3970144		3970180		3970180	
			Adaptor	3000843	Adaptor	3000843	Adaptor	3000843	
			MBD 412 CT (GPL)	1 1/4"	MBD 415 CT	1 1/2"	MBD 415 CT (GPL)	1 1/2"	
				3970197		3970198		3970198	
			Adaptor	3000843	Adaptor	3000843	Adaptor	3000843	
			MBD 415	1 1/2"	MBD 420	2"	MBD 420	2"	
				3970180		3970181		3970181	
			Adaptor	3000843	Adaptor	-	Adaptor	-	
			MBD 415 CT	1 1/2"	MBD 420 CT	2"	MBD 420 CT	2"	
				3970198		3970182		3970182	
			Adaptor	3000843	Adaptor	-	Adaptor	-	
			MBD 420	2"	MBC1200 SE 50	2"	MBC1200 SE 50	2"	
				3970181		3970221		3970221	
			Adaptor	-	Adaptor	-	Adaptor	-	
			MBD 420 CT	2"	MBC1200 SE 50 CT	2"	MBC1200 SE 50 CT	2"	
				3970182		3970225		3970225	
			Adaptor	-	Adaptor	-	Adaptor	-	
			MBC1200 SE 50	2"	MBC 1900 SE 65 FC	DN 65	MBC 1900 SE 65 FC	DN 65	
				3970221		3970222		3970222	
			Adaptor	-	Adaptor	3000825	Adaptor	3000825	
			MBC1200 SE 50 CT	2"	MBC 1900 SE 65 FC CT	DN 65	MBC 1900 SE 65 FC CT	DN 65	
				3970225		3970226		3970226	
			Adaptor	-	Adaptor	3000825	Adaptor	3000825	
			MBC1900 SE 65 FC	DN 65		MBC 3100 SE 80 FC	DN 80	MBC 3100 SE 80 FC	DN 80
				3970222		3970223		3970223	
			Adaptor	3000825		Adaptor	3000826	Adaptor	3000826
			MBC1900 SE 65 FC CT	DN 65		MBC 3100 SE 80 FC CT	DN 80	MBC 3100 SE 80 FC CT	DN 80
				3970225		3970227		3970227	
			Adaptor	3000825		Adaptor	3000826	Adaptor	3000826
Consum gaz metan	Tr. 2	Nm ³ /h	47,9 - 93	70 - 134	92 - 160	127,9 - 229			
	Tr. 1	Nm ³ /h	15	15	24	47			
Alimentare electrică			400V/50Hz						
Putere electrică totală		W	1400	1800	2600	5500			
Nivel zgomot		dB	75	77	78,5	83			
Emisie NOx		mg/kWh	< 130						
Greutate		kg.	70	73	76	82			

Rampă de gaz

Rampă de gaz este livrată separat.

Presiunea maximă a gazului la intrarea în rampele de tip Multibloc este de 300 mbar, iar la cele de tip Compusă este 500 mbar.

Dispozitivul de control al etanșeității, dacă nu este montat pe rampă, poate fi montat ulterior ca accesoriu.

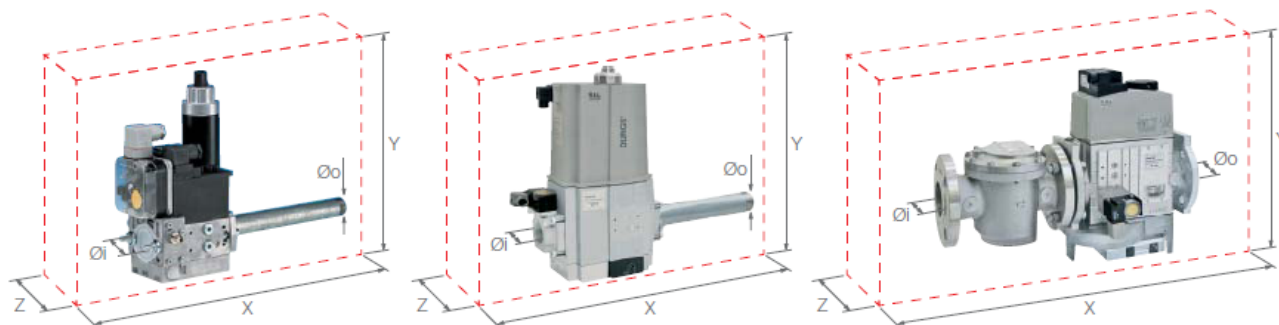

Rampă Multibloc
de tip MBD

Rampă Multibloc de
tip MBC 1200

Rampă Compusă de tip
MBC 1900 - 3100

	Rampă	Cod	ϕ_i	ϕ_o	X, mm	Y, mm	Z, mm	Pres. Gaz, mbar	Kit etanșeitate
Rampă multibloc	MBD 405	3970500	3/4"	3/4"	371	186	120	4 - 20	Accesoriu
	MBD 407	3970553	3/4"	3/4"	371	196	120	4 - 20	Accesoriu
	MBD 410	3970554	1"	3/4"	405	217	145	4 - 20	Accesoriu
	MBD 412	3970144	1 1/4"	1 1/4"	433	217	145	4 - 20	Accesoriu
	MBD 412 CT	3970197	1 1/4"	1 1/4"	433	217	262	4 - 20	Incorporat
	MBD 415	3970180	1 1/2"	1 1/2"	523	250	100	4 - 33	Accesoriu
	MBD 415 CT	3970198	1 1/2"	1 1/2"	523	250	227	4 - 33	Incorporat
	MBD 420	3970181	2"	2"	523	300	100	4 - 33	Accesoriu
	MBD 420 CT	3970182	2"	2"	523	300	227	4 - 33	Incorporat
	MBC 1200 SE 50	3970221	2"	2"	523	425	161	4 - 60	Accesoriu
MBC 1200 SE 50 CT	3970225	2"	2"	523	425	288	4 - 60	Incorporat	
Rampă compusă	MBC 1900 SE 65 FC	3970222	DN 65	DN 65	583	430	237	20 - 40	Accesoriu
	MBC 1900 SE 65 FC CT	3970226	DN 65	DN 65	583	430	364	20 - 40	Incorporat
	MBC 3100 SE 80 FC	3970223	DN 80	DN 80	633	500	240	20 - 40	Accesoriu
	MBC 3100 SE 80 FC CT	3970227	DN 80	DN 80	633	500	367	20 - 40	Incorporat

Diagrame alegere rampă gaz

RS 34 MZ

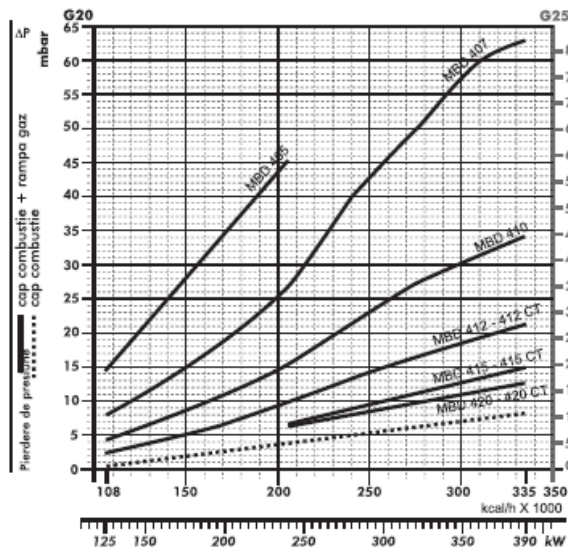

RS 34 MZ

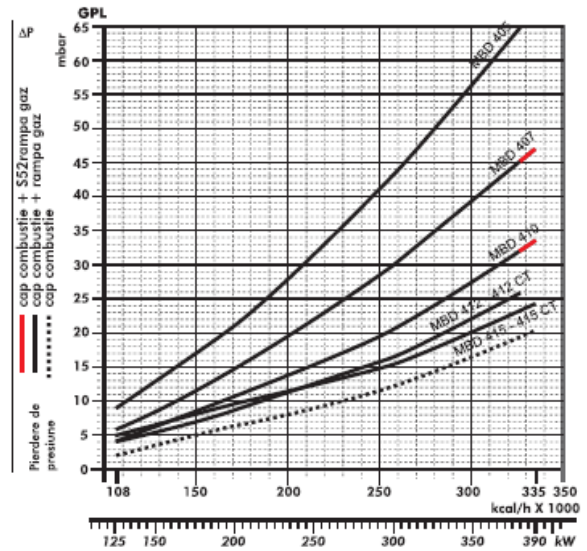

Rampă	Gaz metan		GPL		Kit etanșeitate
	Cod rampă	Adaptor	Cod rampă	Adaptor	
MBD 405	-	-	3970500	3000824	Accesoriu
MBD 407	3970553	3000824	3970553	3000824	Accesoriu
MBD 410	3970554	3000824	3970554	3000824	Accesoriu
MBD 412	3970144	-	3970144	-	Accesoriu
MBD 412 CT	3970197	-	3970197	-	Incorporat
MBD 415	3970180	-	3970180	-	Accesoriu
MBD 415 CT	3970198	-	3970198	-	Incorporat
MBD 420	3970181	3000822	-	-	Accesoriu
MBD 420 CT	3970182	3000822	-	-	Incorporat

RS 44 MZ

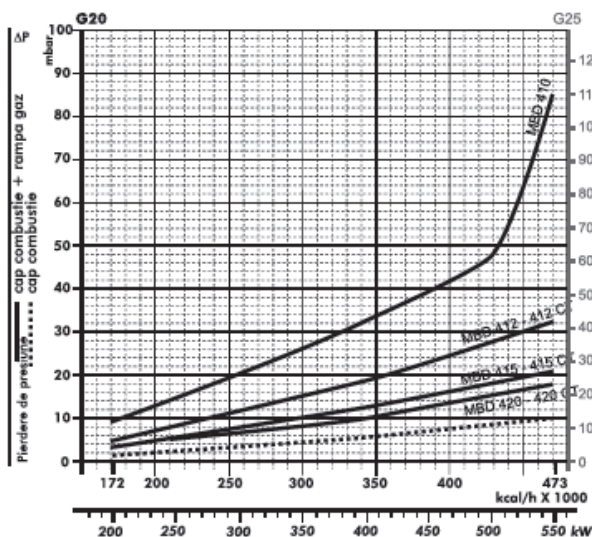

RS 44 MZ

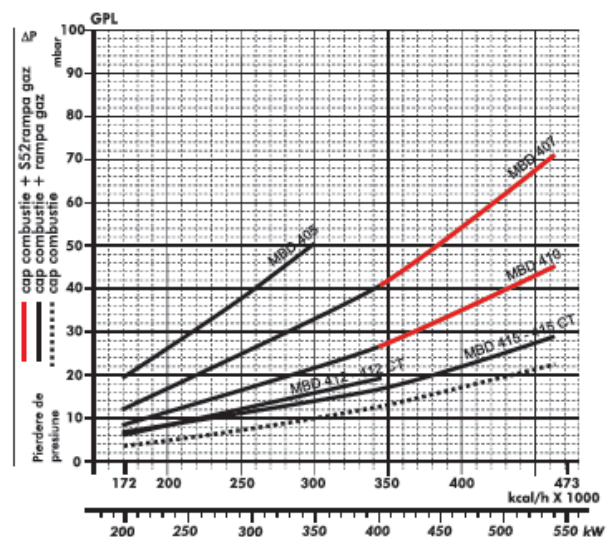

Rampă	Gaz metan		GPL		Kit etanșeitate
	Cod rampă	Adaptor	Cod rampă	Adaptor	
MBD 405	-	-	3970500	3000824	Accesoriu
MBD 407	-	-	3970553	3000824	Accesoriu
MBD 410	3970554	3000824	3970554	3000824	Accesoriu
MBD 412	3970144	-	3970144	-	Accesoriu
MBD 412 CT	3970197	-	3970197	-	Incorporat
MBD 415	3970180	-	3970180	-	Accesoriu
MBD 415 CT	3970198	-	3970198	-	Incorporat
MBD 420	3970181	3000822	-	-	Accesoriu
MBD 420 CT	3970182	3000822	-	-	Incorporat

GAZ NATURAL

RS 50

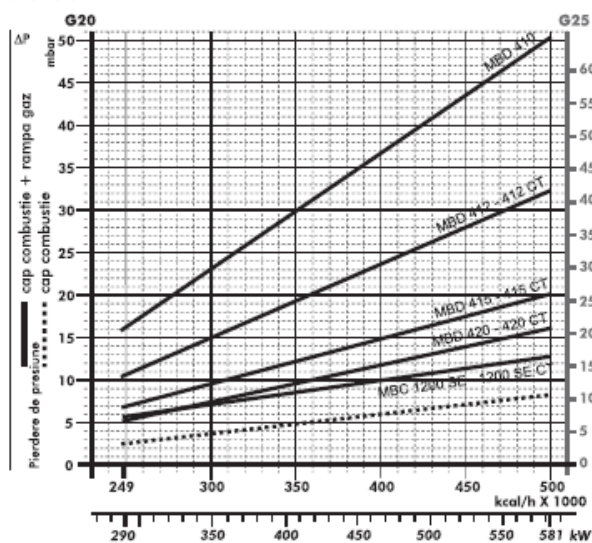

GPL

RS 50

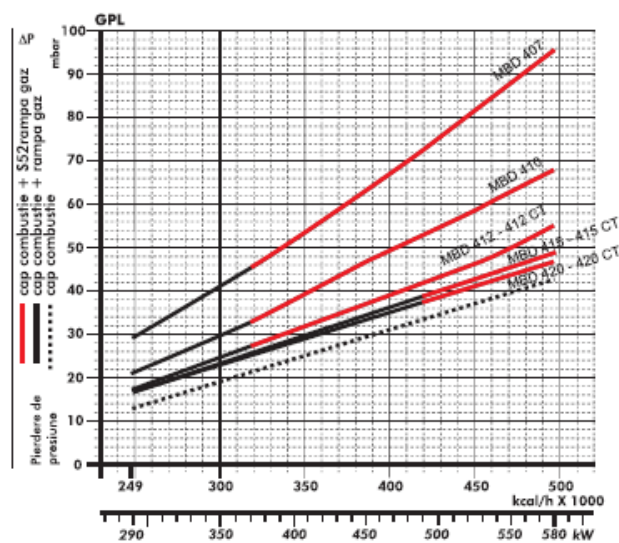

Rampă	Gaz metan		GPL		Kit etanșeitate
	Cod rampă	Adaptor	Cod rampă	Adaptor	
MBD 410	3970554	3000824	3970554	3000824	Accesoriu
MBD 412	3970144	-	3970144	-	Accesoriu
MBD 412 CT	3970197	-	3970197	-	Incorporat
MBD 415	3970180	-	3970180	-	Accesoriu
MBD 415 CT	3970198	-	3970198	-	Incorporat
MBD 420	3970181	3000822	3970181	3000822	Accesoriu
MBD 420 CT	3970182	3000822	3970182	3000822	Incorporat
MBC 1200 SE 50	3970221	3000822	-	-	Accesoriu
MBC 1200 SE 50 CT	3970225	3000822	-	-	Incorporat

RS 64 MZ

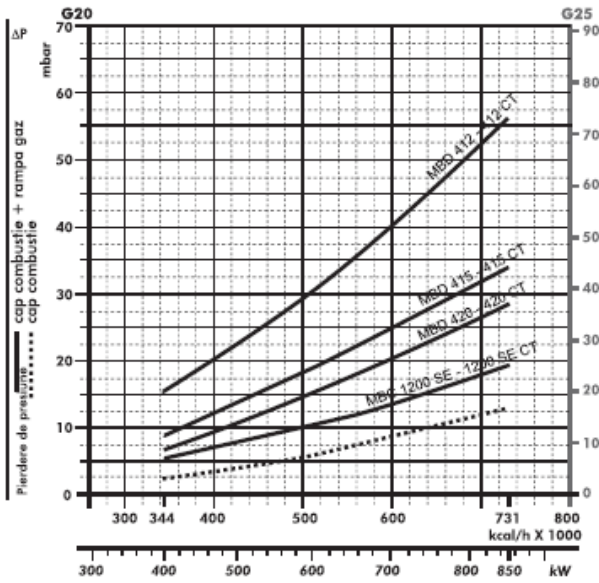

RS 64 MZ

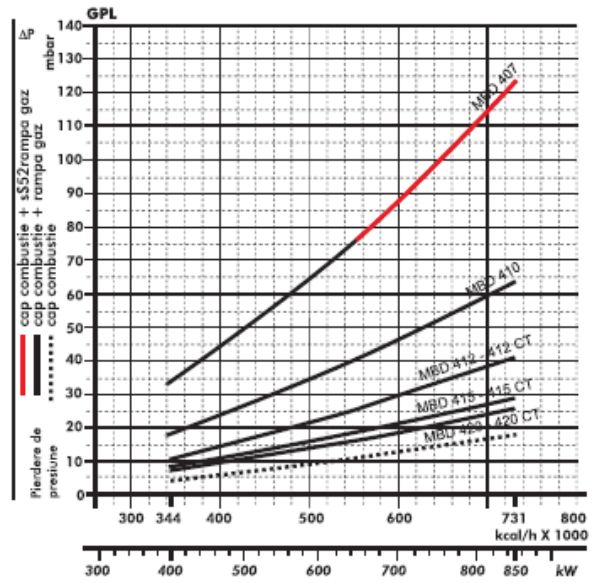

Rampă	Gaz metan		GPL		Kit etanșeitate
	Cod rampă	Adaptor	Cod rampă	Adaptor	
MBD 412	3970144	3000843	3970144	3000843	Accesoriu
MBD 412 CT	3970197	3000843	3970197	3000843	Incorporat
MBD 415	3970180	3000843	3970180	3000843	Accesoriu
MBD 415 CT	3970198	3000843	3970198	3000843	Incorporat
MBD 420	3970181	-	3970181	-	Accesoriu
MBD 420 CT	3970182	-	3970182	-	Incorporat
MBC 1200 SE 50	3970221	-	-	-	Accesoriu
MBC 1200 SE 50 CT	3970225	-	-	-	Incorporat

GAZ NATURAL

RS 70

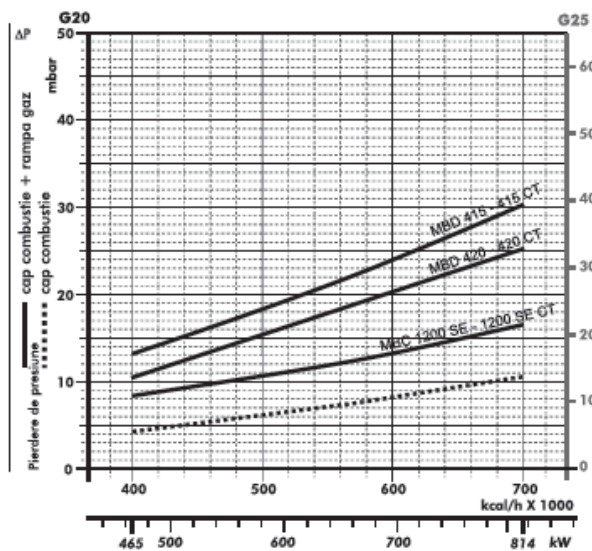

GPL

RS 70

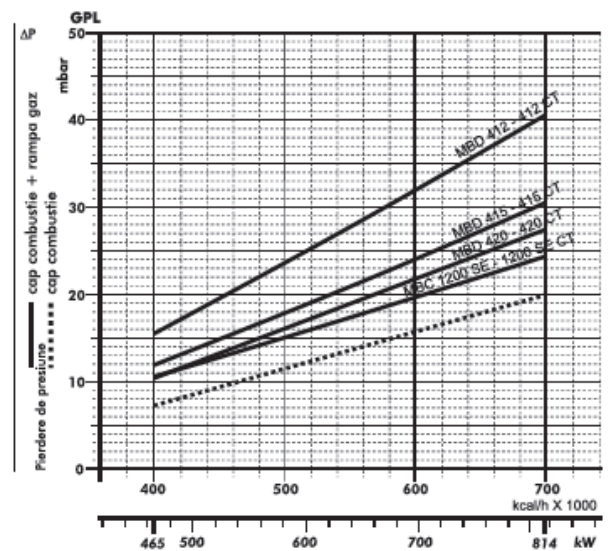

Rampă	Gaz metan		GPL		Kit etanșeitate
	Cod rampă	Adaptor	Cod rampă	Adaptor	
MBD 412	-	-	3970144	3000843	Accesoriu
MBD 412 CT	-	-	3970197	3000843	Incorporat
MBD 415	3970180	3000843	3970180	3000843	Accesoriu
MBD 415 CT	3970198	3000843	3970198	3000843	Incorporat
MBD 420	3970181	-	3970181	-	Accesoriu
MBD 420 CT	3970182	-	3970182	-	Incorporat
MBC 1200 SE 50	3970221	-	3970221	-	Accesoriu
MBC 1200 SE 50 CT	3970225	-	3970225	-	Incorporat
MBC 1900 SE 65 FC	3970222	3000825	-	-	Accesoriu
MBC 1900 SE 65 FC CT	3970226	3000825	-	-	Incorporat

RS 100

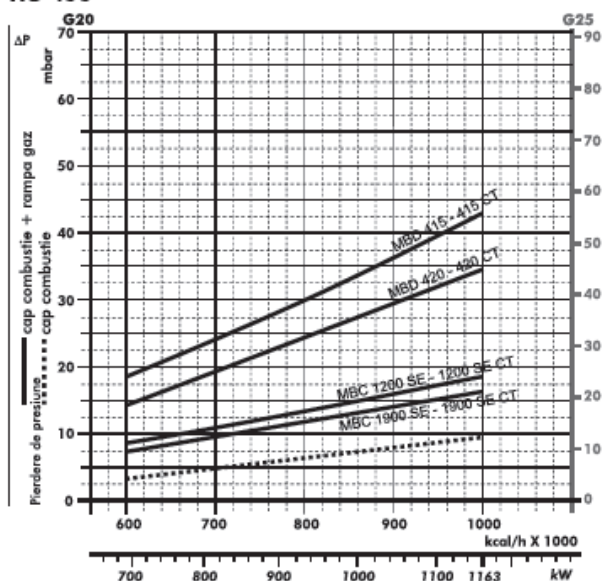

RS 100

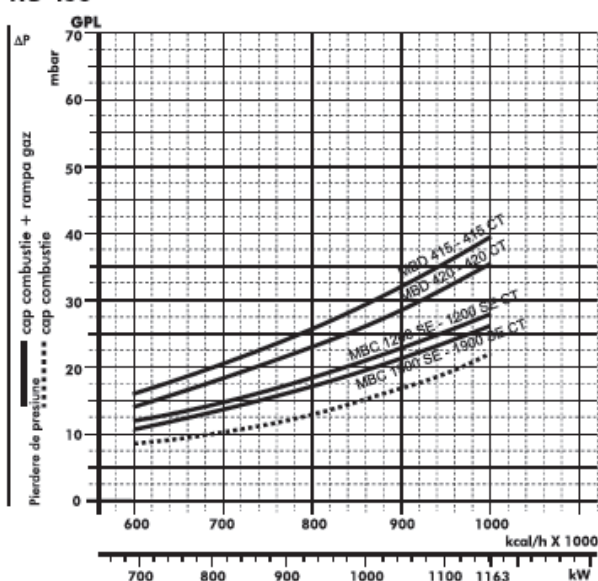

Rampă	Gaz metan		GPL		Kit etanșeitate
	Cod rampă	Adaptor	Cod rampă	Adaptor	
MBD 415	3970180	3000843	3970180	3000843	Accesoriu
MBD 415 CT	3970198	3000843	3970198	3000843	Incorporat
MBD 420	3970181	-	3970181	-	Accesoriu
MBD 420 CT	3970182	-	3970182	-	Incorporat
MBC 1200 SE 50	3970221	-	3970221	-	Accesoriu
MBC 1200 SE 50 CT	3970225	-	3970225	-	Incorporat
MBC 1900 SE 65 FC	3970222	3000825	3970222	3000825	Accesoriu
MBC 1900 SE 65 FC CT	3970226	3000825	3970226	3000825	Incorporat

RS 130

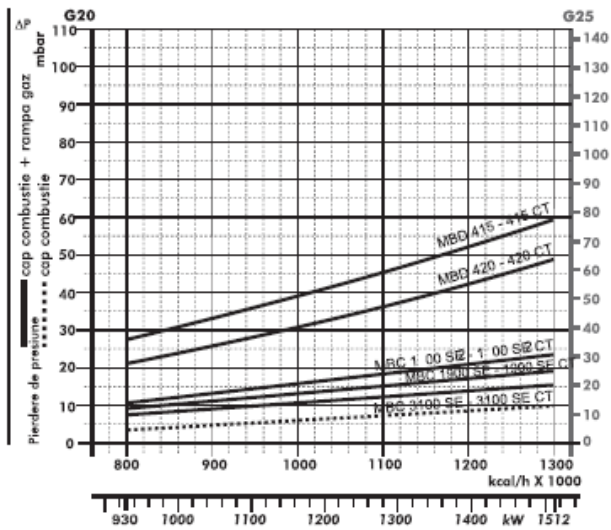

RS 130

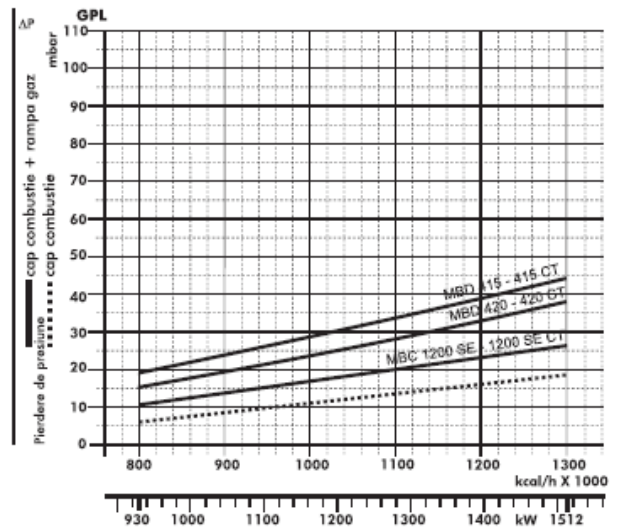

Rampă	Gaz metan		GPL		Kit etanșeitate
	Cod rampă	Adaptor	Cod rampă	Adaptor	
MBD 415	3970180	3000843	3970180	3000843	Accesoriu
MBD 415 CT	3970198	3000843	3970198	3000843	Incorporat
MBD 420	3970181	-	3970181	-	Accesoriu
MBD 420 CT	3970182	-	3970182	-	Incorporat
MBC 1200 SE 50	3970221	-	3970221	-	Accesoriu
MBC 1200 SE 50 CT	3970225	-	3970225	-	Incorporat
MBC 1900 SE 65 FC	3970222	3000825	3970222	3000825	Accesoriu
MBC 1900 SE 65 FC CT	3970226	3000825	3970226	3000825	Incorporat
MBC 3100 SE 80 FC	3970223	3000826	-	-	Accesoriu
MBC 3100 SE 80 FC CT	3970227	3000826	-	-	Incorporat

RS 190

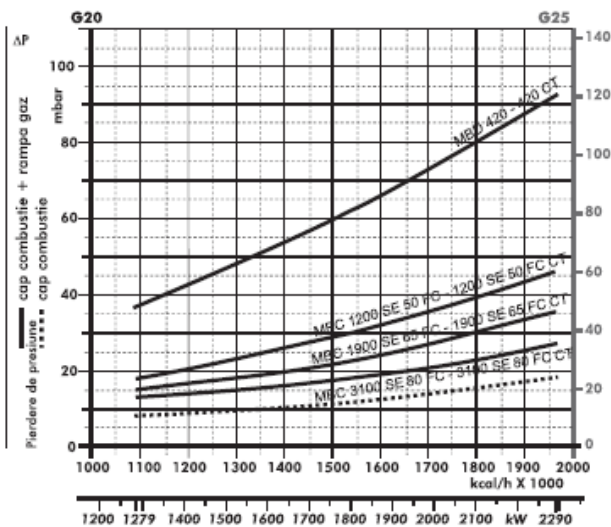

RS 190

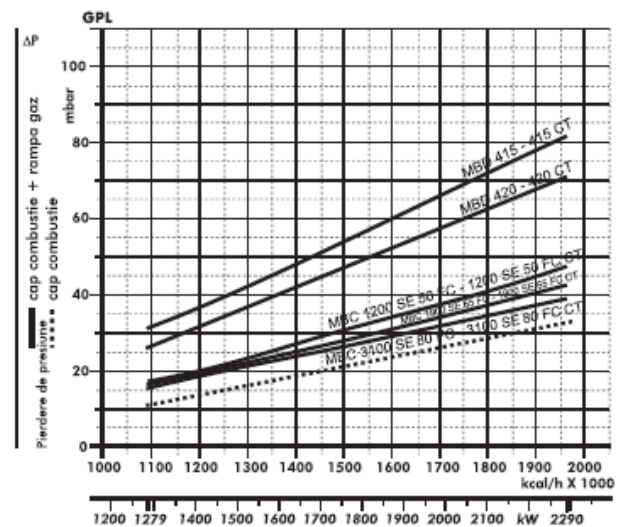

Rampă	Gaz metan		GPL		Kit etanșeitate
	Cod rampă	Adaptor	Cod rampă	Adaptor	
MBD 415	-	-	3970180	3000843	Accesoriu
MBD 415 CT	-	-	3970198	3000843	Incorporat
MBD 420	3970181	-	3970181	-	Accesoriu
MBD 420 CT	3970182	-	3970182	-	Incorporat
MBC 1200 SE 50	3970221	-	3970221	-	Accesoriu
MBC 1200 SE 50 CT	3970225	-	3970225	-	Incorporat
MBC 1900 SE 65 FC	3970222	3000825	3970222	3000825	Accesoriu
MBC 1900 SE 65 FC CT	3970226	3000825	3970226	3000825	Incorporat
MBC 3100 SE 80 FC	3970223	3000826	3970223	3000826	Accesoriu
MBC 3100 SE 80 FC CT	3970227	3000826	3970227	3000826	Incorporat

Dimensiuni

RS 34/M MZ - 44/M MZ

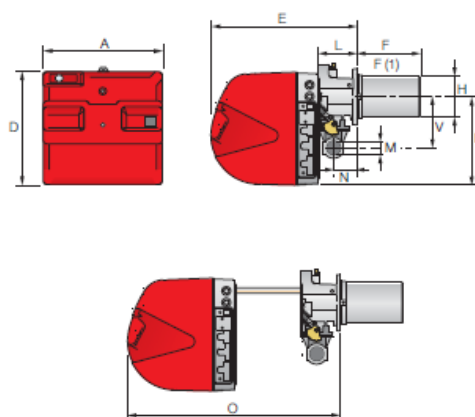

RS 50/M MZ

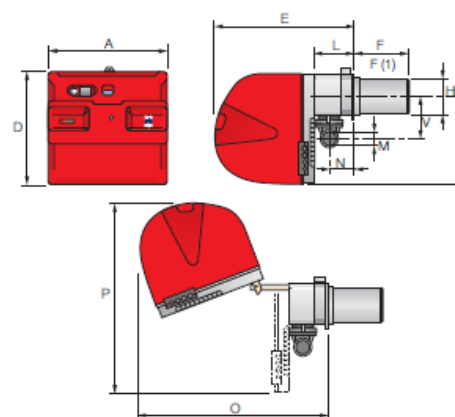

MODEL	A	D	E	F - F(1)	H	I	L	M	N	O	P	V
► RS 34/M MZ	442	422	508	216 - 351	140	305	138	1"1/2	84	780	-	177
► RS 44/M MZ	442	422	508	216 - 351	152	305	138	1"1/2	84	780	-	177
► RS 50/M MZ	476	474	580	216 - 351	152	352	164	1"1/2	108	810	719	168

(1) Dimensiuni pentru varianta cu cap lung

RS 64/M MZ

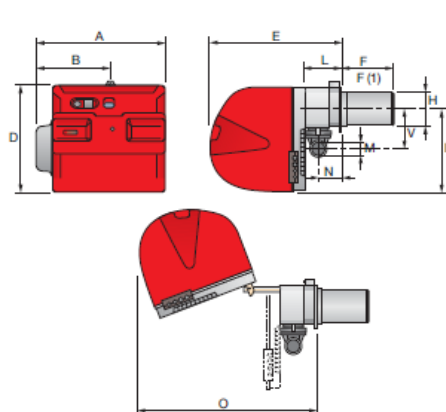

RS 70/M - 100/M - 130/M - 190/M - 250/M MZ

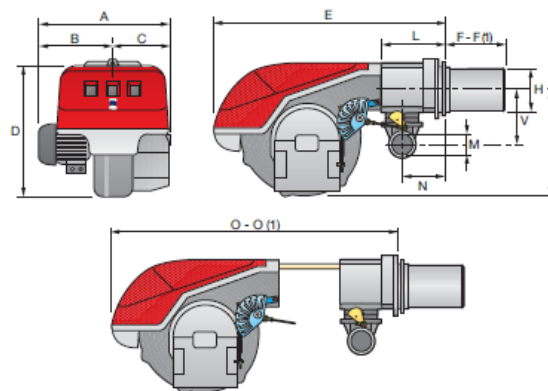

MODEL	A	B	C	D	E	F - F(1)	H	I	L	M	N	O - O(1)	V
▶ RS 64/M MZ	533	300	-	490	640	250 - 385	179	352	222	2"	134	870 - -	221
▶ RS 70/M	511	296	215	555	840	250 - 385	179	430	214	2"	134	1161 - 1296	221
▶ RS 100/M	527	312	215	555	840	250 - 385	179	430	214	2"	134	1161 - 1296	221
▶ RS 130/M	553	338	215	555	840	280 - 415	189	430	214	2"	134	1161 - 1296	221
▶ RS 190/M	681	366	315	555	872	370 - 520	222	430	230	2"	150	1328 - -	221
▶ RS 250/M MZ	732	427	305	555	872	370 - 520	222	430	230	2"	150	1328 - -	262

(1) Dimensiuni pentru varianta cu cap lung

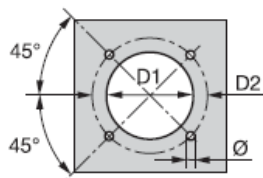

MODEL	D1	D2	Ø
▶ RS 34/M MZ	160	224	M8
▶ RS 44/M MZ	160	224	M8
▶ RS 50/M MZ	160	224	M8
▶ RS 64/M MZ	185	275-325	M12
▶ RS 70/M	185	275-325	M12
▶ RS 100/M	185	275-325	M12
▶ RS 130/M	185	275-325	M12
▶ RS 190/M	230	325-368	M16
▶ RS 250/M MZ	230	325-368	M16

Accesorii

Cap de ardere lung

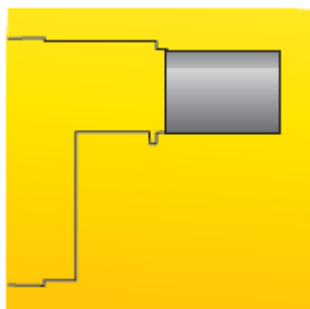

Arzător	Cap ardere standard, mm	Cap ardere lung	
		mm	Cod
RS 34/M MZ	216	351	3010428
RS 44/M MZ	216	351	3010429
RS 50/M	216	351	3010078
RS 64/M MZ	250	385	3010427
RS 70/M	250	385	3010117
RS 100/M	250	385	3010118
RS 130/M	280	415	3010119
RS 190/M	370	520	3010443

Set pentru ventilare continuă

Pentru aplicații care necesită ventilarea arzătorului chiar și atunci când flacăra este stinsă, se folosește un kit special conform tabelului de mai jos:



Arzător	Cod Kit
RS 34/M MZ - RS 44/M MZ	3010449
RS 50/M - RS 64/M MZ - RD 70/M - RS 100/M - RS 130/M - RS 190/M	3010094

Kit GPL

Pentru ca arzătorul să funcționeze cu GPL se folosește un kit de transformare conform tabelului de mai jos:



Arzător	Cod Kit GPL	
	Cap de ardere standard	Cap de ardere lung
RS 34/M MZ	3010423	3010423
RS 44/M MZ	3010424	3010424
RS/M 50	20008173	20008173
RS 64/M MZ	3010434	3010435
RS 70/M	20008175	20008176
RS 100/M	20008177	20008178
RS 130/M	20008179	20008180
RS 190/M	3010166	3010166

Regulator modulare și sonde

Pentru a funcționa în regim modulant, arzătoarele din seria RS/M trebuie echipate cu un regulator de tip RWF 40 și o sondă conform tabelelor de mai jos:



Arzător	Cod Kit
RS 34/M MZ - RS 44/M MZ	3010417
RS 50/M - RS 64/M MZ	3010212
RD 70/M - RS 100/M - RS 130/M - RS 190/M	3010414



Model arzător	Tip sondă	Plajă de lucru	Cod
Toate modelele RS/M	Temperatură PT 100	-100 ÷ 500 °C	3010110
	Presiune 4 ÷ 20 mA	0 ÷ 2,5 bar	3010213
	Presiune 4 ÷ 20 mA	0 ÷ 16 bar	3010214































Kit de reducere a vibrațiilor



Arzător	Cod kit
RS 50/M TC - RS 50/M TL	3010200
RS 70/M TC - RS 70/M TL	3010201
RS 100/M TC - RS 100/M TL	3010202
RS 130/M TC	3010373
RS 100/M TL	3010374
RS 190/M TC	3010375

Adaptoare

Se folosesc atunci când diametrul rampei de gaz diferă de racordul arzătorului. În tabelul de mai jos sunt indicate tipurile de adaptoare corelate cu rampele arzătoarelor.

ARZĂTOR	RAMPĂ	DIMENSIUNI	COD ADAPTOR
▶ RS 34 MZ	MBD 405 - 407 - 410	3/4"  1 1/2"	3000824
	MBD 420	2"  1 1/2"	3000822
▶ RS 44 MZ	MBD 405 - 407 - 410	3/4"  1 1/2"	3000824
	MBD 420	2"  1 1/2"	3000822
▶ RS 50	MBD 407 - 410	3/4"  1 1/2"	3000824
	MBD 420 - MBC 1200	2"  1 1/2"	3000822
▶ RS 64 MZ	MBD 407 - 410	3/4"  1 1/2"	3000824
		1 1/2"  2"	+ 3000843
	MBD 412 - 415	1 1/2"  2"	3000843
▶ RS 70	MBD 410	3/4"  1 1/2"	3000824
		1 1/2"  2"	+ 3000843
	MBD 412 - 415	1 1/2"  2"	3000843
	MBC 1900	DN 65  2 1/2"  1 1/2"	3000825
		 2"	
MBC 3100	DN 80  2 1/2"  2"	3000826	
▶ RS 100	MBD 410	3/4"  1 1/2"	3000824
		1 1/2"  2"	+ 3000843
	MBD 415	1 1/2"  2"	3000843
	MBC 1900	DN 65  2 1/2"  1 1/2"	3000825
		 2"	
MBC 3100	DN 80  2 1/2"  2"	3000826	
▶ RS 130	MBD 415	1 1/2"  2"	3000843
	MBC 1900	DN 65  2 1/2"  1 1/2"	3000825
		 2"	
MBC 3100	DN 80  2 1/2"  2"	3000826	

ARZĂTOR	RAMPĂ	DIMENSIUNI	COD ADAPTOR
	MBD 415	1 1/2"  2"	3000843
▶ RS 190	MBC 1900	DN 65  2 1/2"  1 1/2"  2"	3000825
	MBC 3100	DN 80  2 1/2"  2"	3000826