

# GULLIVER RG

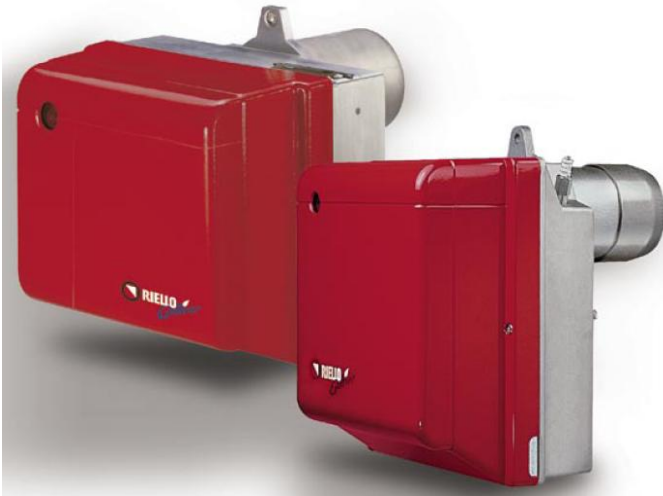

## CARACTERISTICI CONSTRUCTIVE

- Arzător cu aer insuflat pe motorină cu una sau două trepte de funcționare
- Domeniu de utilizare: cazane de apă caldă sau cu ulei diatermic, cazane de abur
- Echipat cu carcasă atenuatoare de zgomot
- Reglajul aerului se poate face cu carcasa montată
- Alimentare electrică: 230V/50Hz
- Vâscozitate combustibil la 20°C, max: 6 mm<sup>2</sup>/s
- Temperatură maximă combustibil: 50°C
- Temperatură maximă aer: 40°C
- Densitate combustibil: 0,85 kg/dm<sup>3</sup>
- Domeniu de presiune pompă: 8 – 15 bar
- Livrare standard cu duză și racord flexibil pentru motorină

## TIPURI CONSTRUCTIVE

- RG – o treaptă de funcționare
- RG D – două trepte de funcționare
- RG R – cu preîncălzitor
- RG RK – cu preîncălzitor, cap ardere conic
- RG S – cu temporizator
- RG KD – cu preîncălzitor, două trepte de funcționare
- RG RKD - cu preîncălzitor, două trepte de funcționare, cap ardere conic

## Seria GULLIVER RG – o treaptă de funcționare

GULLIVER			RG0.R	RG0.1	RG0.1R	RG1	RG1R	RG1RK	RG2	RG3	RG4S	RG5S
Putere termică	max.	kW	27,3	35,6	36,7	60	60	60	119	178	237	309,5
	min.	kW	16,6	22,5	21,3	32	20	15	47	83	118,5	160
Consum motorină	max.	kg/h	2,3	3,0	3,1	5,0	5,0	5,0	10,0	15,0	20,0	26,1
	min.	kg/h	1,4	1,9	1,8	2,7	1,7	1,3	4,0	7,0	10,0	13,5
Preîncălzitor combustibil			Da	Nu	Da	Nu	Da	Da	Nu	Nu	Nu	Nu
Putere electrică total absorbită		W	290	170	290	170	290	290	180	390	390	470
Putere electrică preîncălzitor		W	70	-	70	-	120	120	-	-	-	-
Nivel zgomot		dB	56	57	57	60	60	60	61	64	64	71
Greutate		kg.	9	9	9	13	13	13	13	15	18	18

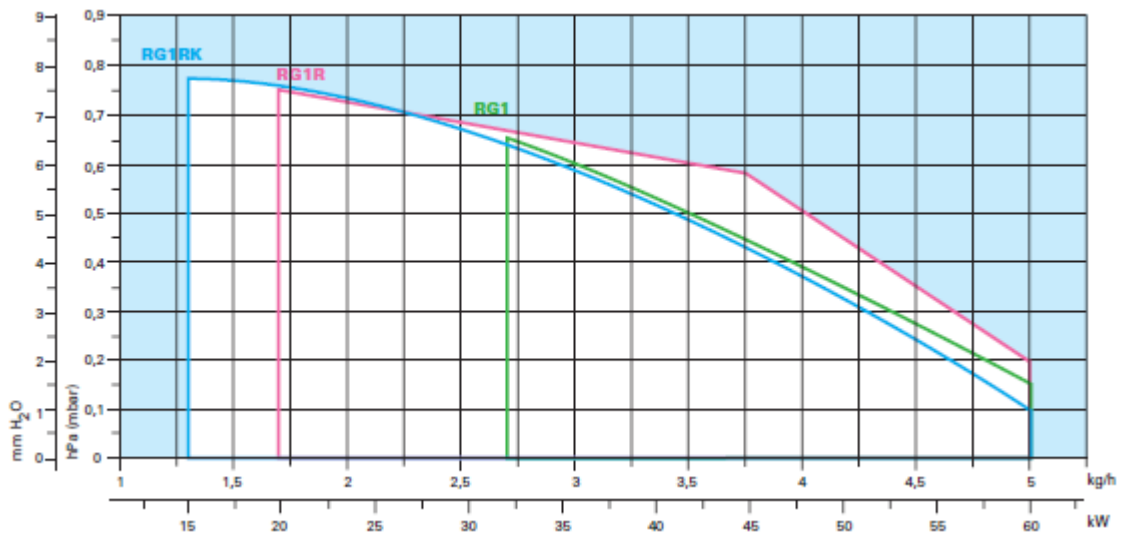
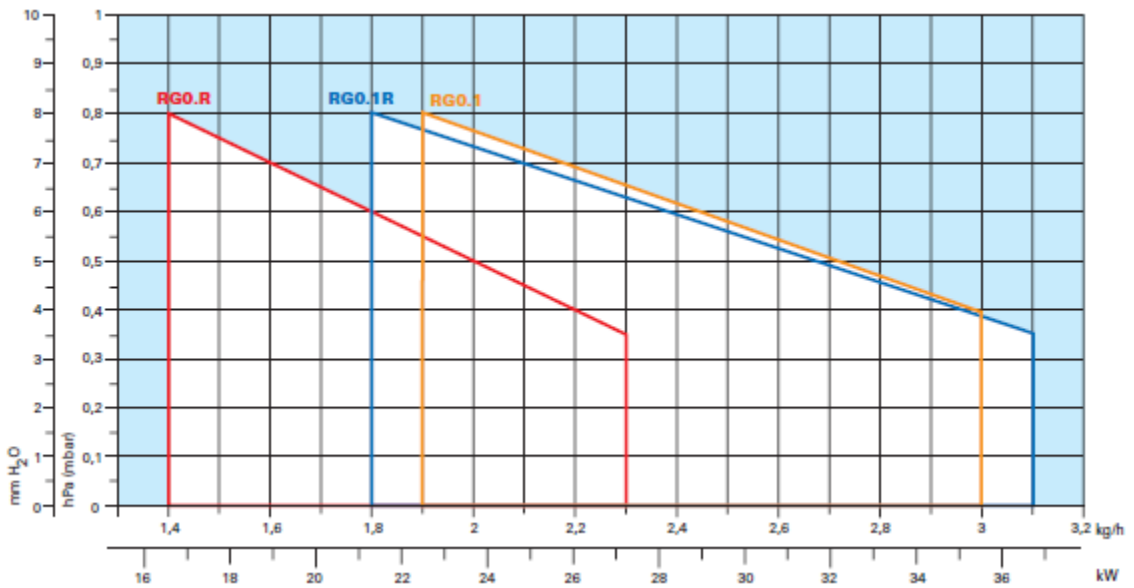

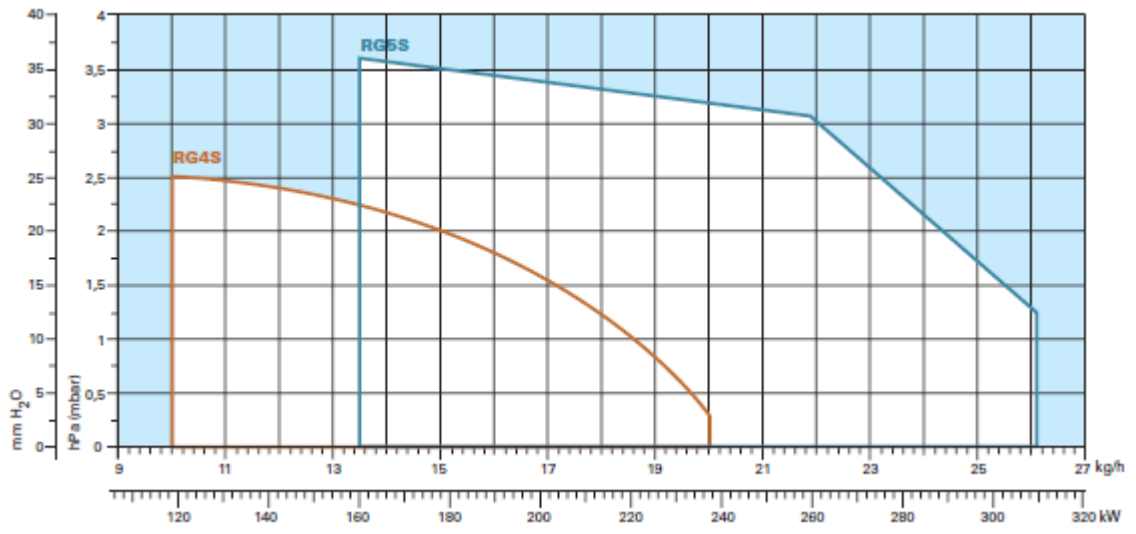
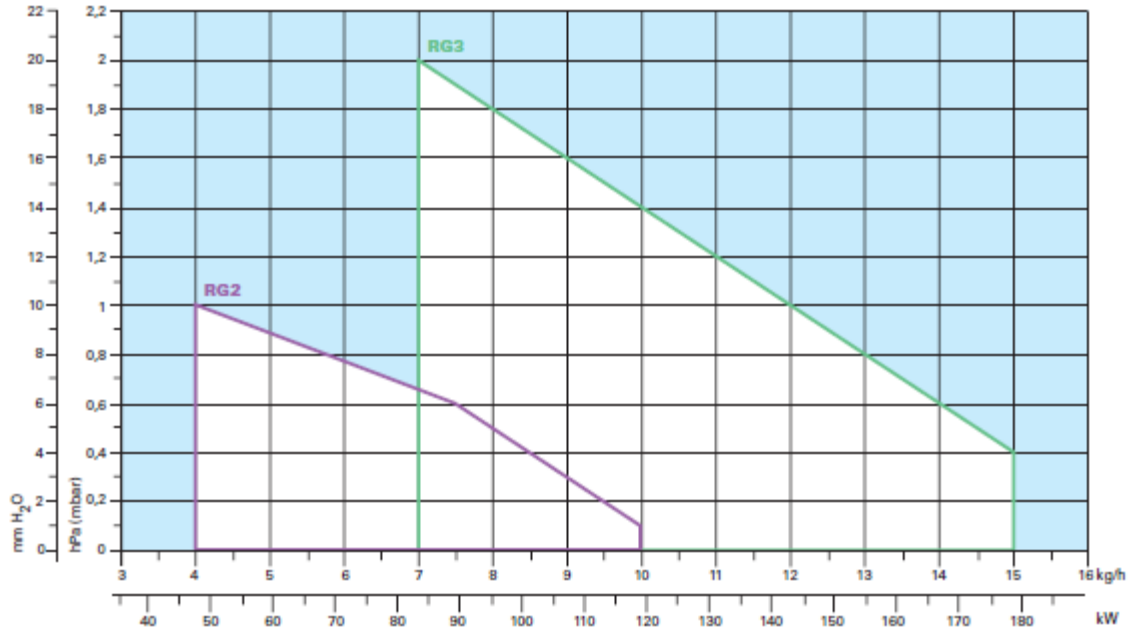

## Dimensiuni

GULLIVER RG0

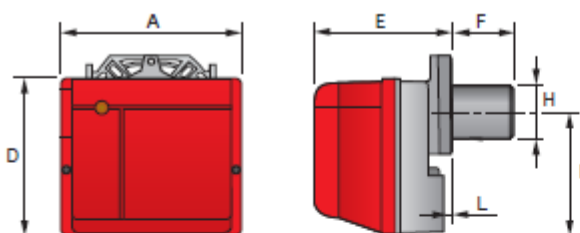

GULLIVER RG

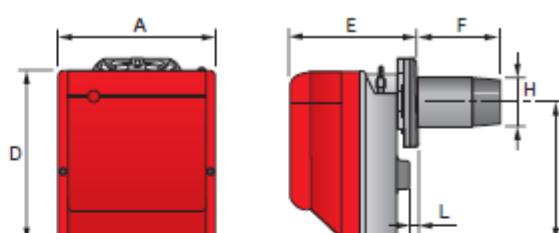

Model	A	D	E	F	H	I	L
▶ RG0.R	255	210	205	93	84	168	5
▶ RG0.1R	255	210	205	93	84	168	5
▶ RG0.1	255	210	205	93	84	168	5
▶ RG1	234	254	196	93	84	210	4
▶ RG1R	234	254	196	93	84	210	4
▶ RG1RK	234	254	196	111	84	210	4
▶ RG2	255	280	202	115	95	230	10
▶ RG3	300	345	228	142	123	285	12
▶ RG4S	300	345	228	142	123	285	12
▶ RG5S	300	345	247	155	125	285	12,5

RG0.R - RG0.1R - RG0.1  
RG1 - RG1R - RG1RK - RG2

RG3 - RG4S  
RG5S

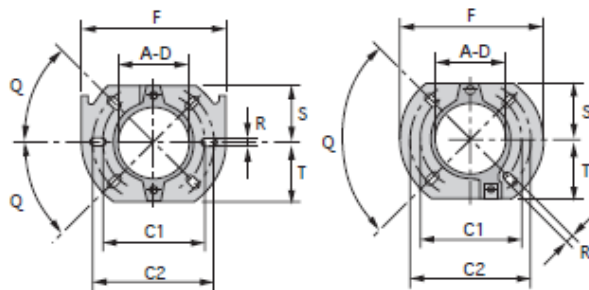

Model	A-D	C1	C2	F	Q	R	S	T
▶ RG0.R - RG0.1R RG0.1 - RG1 RG1R - RG1RK	91	130	150	180	45	11	72	72
▶ RG2	106	140	168	189	45	11	83	83
▶ RG3 - RG4S - RG5S	127	160	190	213	90	11	99	99

Lungimea capului de ardere			
Model	Standard	Lung	
	mm	mm	Cod
RG1 - RG1R	93	163	3000963
RG1RK	111	181	3000982
RG2	115	180	3000964
RG2	115	300	3000967
RG3	142	210	3000965
RG3	142	300	3000968
RG4S	142	210	3000966
RG4S	142	300	3000969
RG5S	155	300	3001068

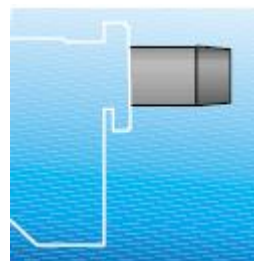

## Seria GULLIVER RG D – două trepte de funcționare

GULLIVER			RG1RKD	RG2D	RG3D	RG4D	RG5D
Putere termică	max.	kW	60	118	178	237	296
	min.	kW	14/17	42/49	65/83	106/130	95/142
Consum motorină	max.	kg/h	5	10	15	20	25
	min.	kg/h	1,2/1,45	3,6/4,1	5,5/7	9/11	8/12
Preîncălzitor combustibil			Da	Nu	Nu	Nu	Nu
Putere electrică total absorbită		W	290	180	390	390	470
Putere electrică preîncălzitor		W	120	-	-	-	-
Nivel zgomot		dB	60	61	64	64	71
Greutate		kg.	13	14	17	17	17

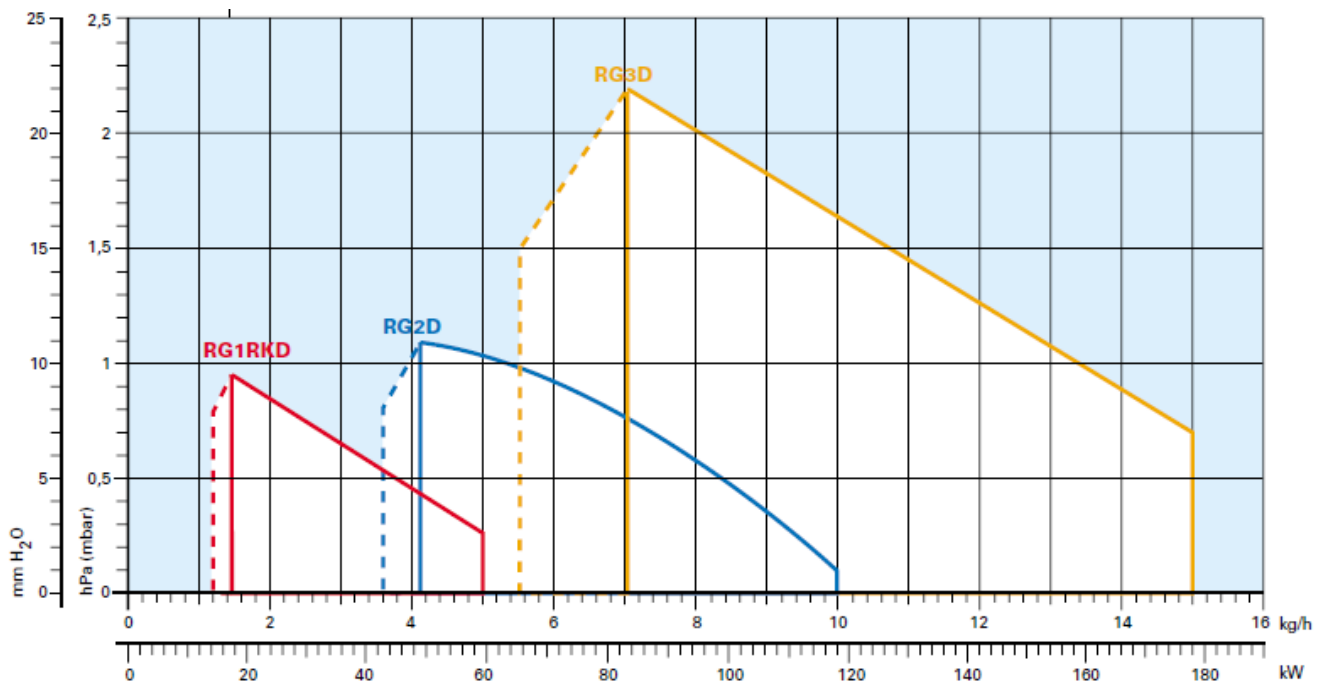

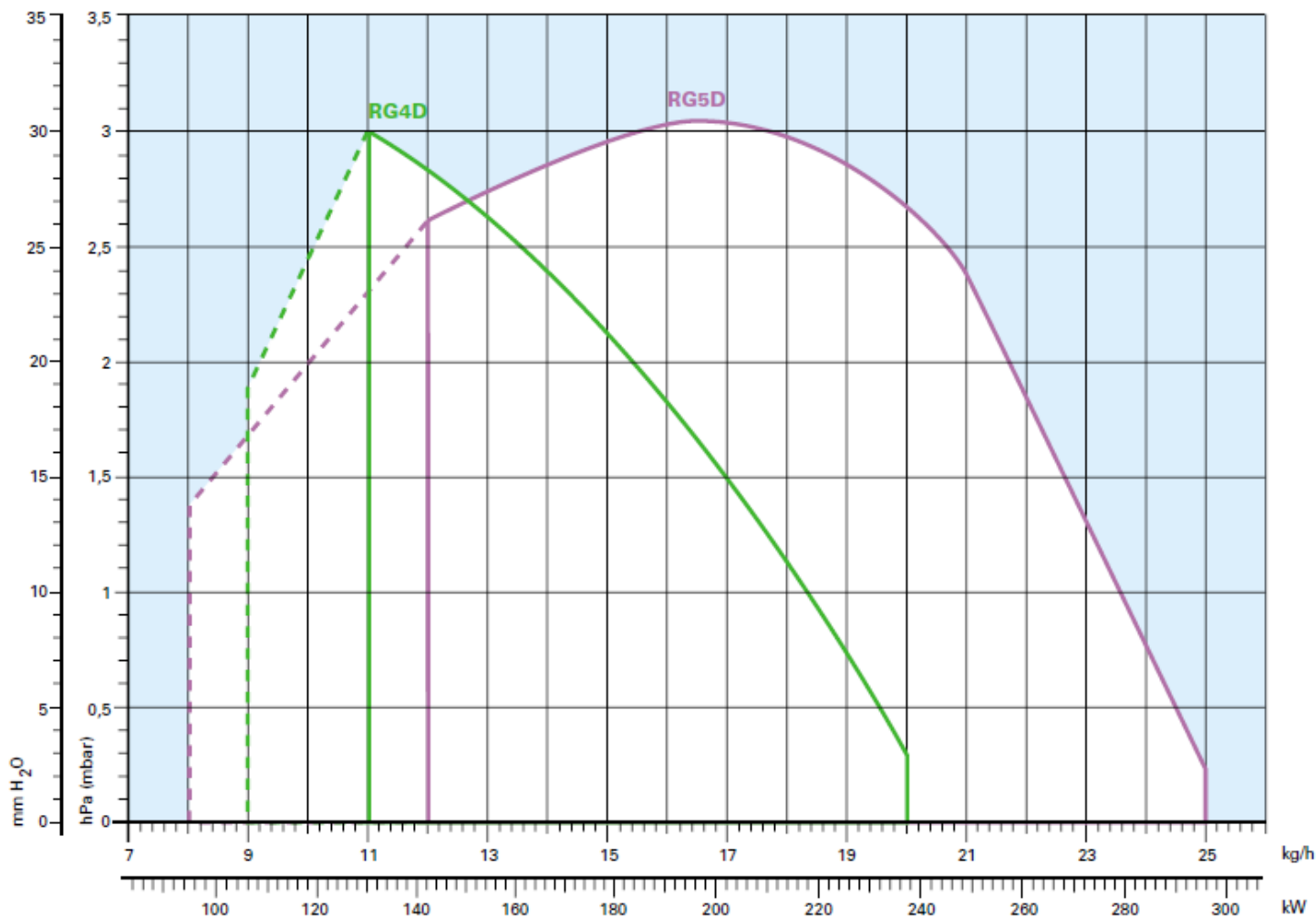

## Dimensiuni

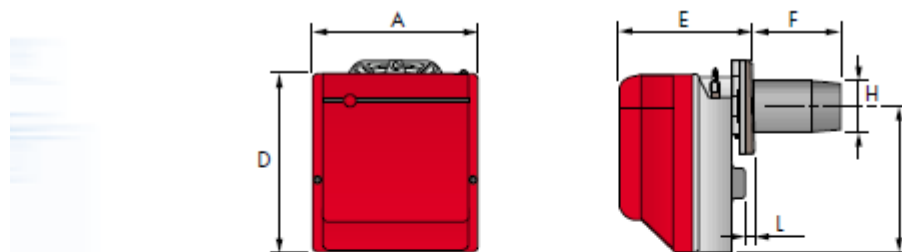

Model	A	D	E	F	H	I	L
▶ RG1RKD	234	254	196	111	84	210	4
▶ RG2D	255	280	202	115	95	230	10
▶ RG3D	300	345	228	142	123	285	12
▶ RG4D	300	345	228	142	123	285	12
▶ RG5D	300	345	247	159	125	285	12,5

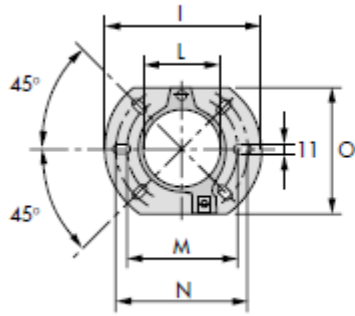

Model	I	L	M	N	O
▶ RG1RKD	180	91	130	150	144
▶ RG2D	189	106	140	165	166
▶ RG3D	213	127	160	190	198
▶ RG4D	213	127	160	190	198
▶ RG5D	213	127	160	190	198

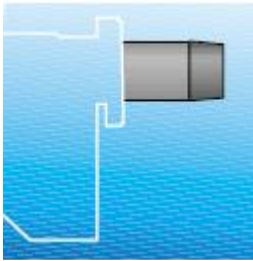

Lungimea capului de ardere			
Model	Standard	Lung	
	mm	mm	Cod
RG1RKD	111	181	3000982
RG2D	115	180	3000964
RG2D	115	300	3000967
RG3D	142	210	3000965
RG3D	142	300	3000968
RG4D	142	210	3000966
RG4D	142	300	3000969
RG5D	159	300	3000981