

LOW NO_x TWO STAGE PROGRESSIVE AND MODULATING GAS BURNERS

► GULLIVER BS/M SERIES

► BS2/M	26/49 ÷ 91 kW
► BS3/M	48/79 ÷ 195 kW
► BS4/M	68/140 ÷ 250 kW



The Riello Gulliver BS/M series of two stage, progressive or modulating gas burners, is a complete range of Low NO_x emission products, developed to respond to any request for home heating, conforming to the most severe standards regarding the reduction of polluting emissions.

This series of burners is available in three different models with an output ranging from 26 to 250 kW, divided in three different structures.

All the models use the same components designed by Riello for the Gulliver series. The high quality level guarantees safe working.

In developing these burners, special attention was paid to reducing noise, the ease of installation and adjustment, to obtaining the smallest size possible to fit into any sort of boiler available on the market.

Two stage operation guarantees high level performance from the thermal unit. All the models are approved by the EN 676 European Standard and conform to European Directives, Gas Appliance, EMC, Low Voltage, Boiler Efficiency.

All the Gulliver BS/M burners are tested before leaving the factory.

TECHNICAL DATA

Model		▼ BS2/M	▼ BS3/M	▼ BS4/M
Burner operation mode		Modulating Proportional		
Modulation ratio at max. output		1 ÷ 3		
Servomotor	type	LANDIS SQN91		
	run time	24		
Heat output	kW	26/49 - 91	48/79 - 195	68/140 - 250
	Mcal/h	22,4/42,1 - 78,2	41,3/67,9 - 167,7	58,5/120,4 - 215
Working temperature		°C min./max. 0/40		
Net calorific value G20 gas		kWh/Nm ³ 10		
G20 gas density		kg/Nm ³ 0,71		
G20 gas delivery		2,6/4,9 - 9,1	4,8/7,9 - 19,5	6,8/14 - 25
Net calorific value G25 gas		kWh/Nm ³ 8,6		
G25 gas density		kg/Nm ³ 0,78		
G25 gas delivery		3/5,5 - 10,6	5,6/9,2 - 22,7	7,9/16,3 - 29,1
Net calorific value LPG gas		kWh/Nm ³ 25,8		
LPG gas density		kg/Nm ³ 2,02		
LPG gas delivery		1/1,9 - 3,5	1,9/3,1 - 7,6	2,6/5,4 - 9,7
Fan		type Centrifugal with forward curve blades		
Air temperature		max °C 40		
Electrical supply		Ph/Hz/V 1/50/230 ±10%		
Auxiliary electrical supply		Ph/Hz/V --		
Control box		type LANDIS LMG 22		
Total electrical power		0,180	0,350	0,530
Auxiliary electrical power		kW --		
Protection level		IP 40		
Motor electrical power		0,09	0,15	0,25
Rated motor current		0,8	1,8	1,9
Motor start up current		2,68	5,6	8
Motor protection level		IP 20		
Ignition transformer		type Separated from the control box		
		V1 - V2 230V - 1 x 15 kV		
		I1 - I2 0,2 A - 25 mA		
Operation		Intermittent (at least one stop every 24 h)		
Sound pressure		62	66	71
Sound power		W --		
CO emission		5	6	9
NOx emission		63	75	62
Directive		90/396/EEC, 89/336/EEC, 73/23/EEC, 92/42/EEC		
Conforming to		EN 676		
Certification		CE - 0085 BN 0609		

Reference conditions:

Temperature: 20°C

Pressure: 1013 mbar

Altitude: 0 m a.s.l.

Noise measured at a distance of 1 meter.

Since the Company is constantly engaged in the production improvement, the aesthetic and dimensional features, the technical data, the equipment and the accessories can be changed.
This document contains confidential and proprietary information of RIELLO S.p.A. Unless authorised, this information shall not be divulged, nor duplicated in whole or in part.

FIRING RATES

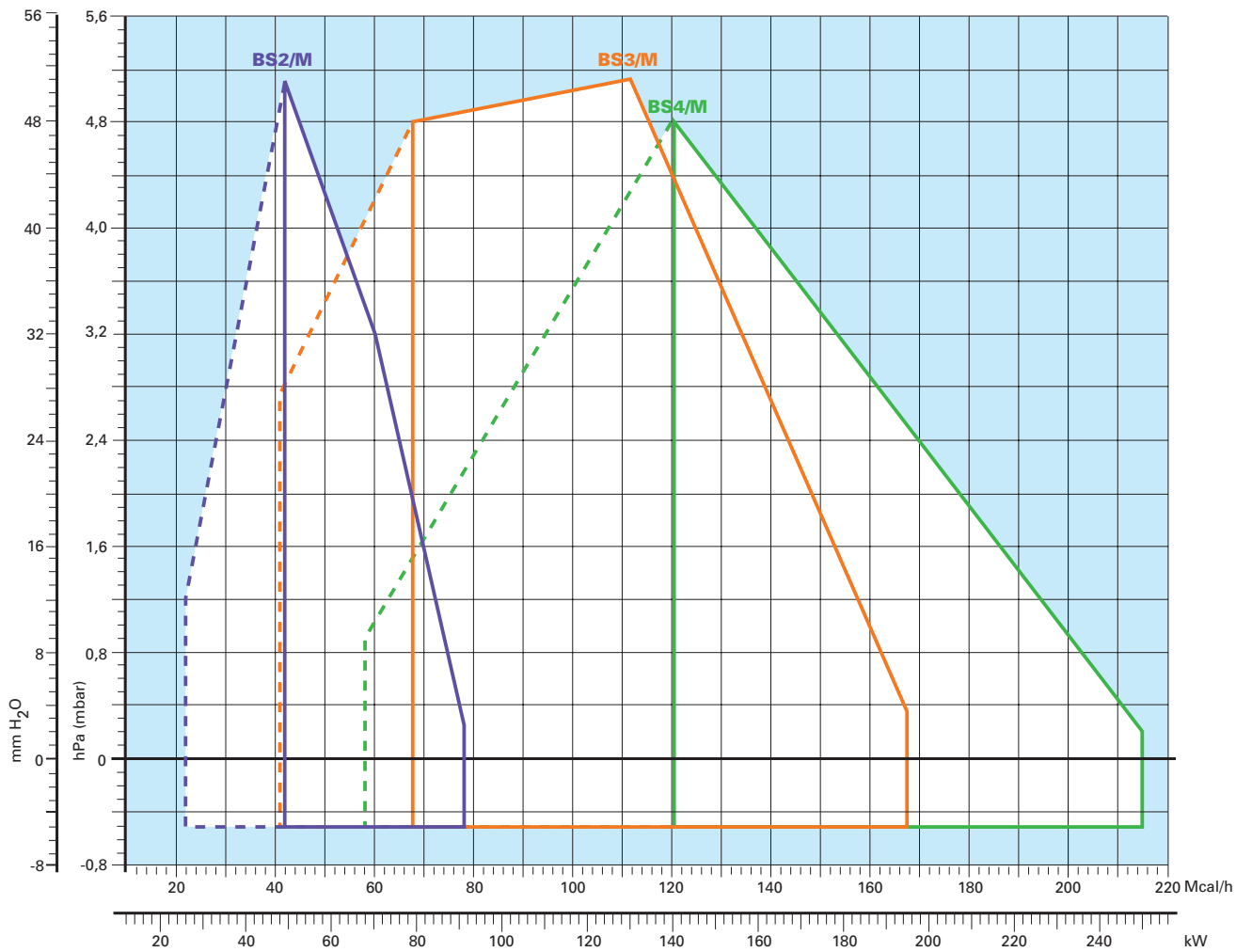

 Useful working field for choosing the burner

 Modulation range

Test conditions conforming to EN 676:

Temperature: 20 °C

Pressure: 1013 mbar

Altitude: 0 m a.s.l.



FUEL SUPPLY

▶ GAS TRAIN

The burners are set for fuel supply from either the right or left hand sides.

Depending on the fuel output and the available pressure in the supply line, you should check the correct gas train to be adapted to the system requirements.

The gas train is CG 120 - CG 220 type, containing the main components in a single unit.



Gas train installed on the burner



Gas train and RWF 40 installed on the burner

ALL MODELS

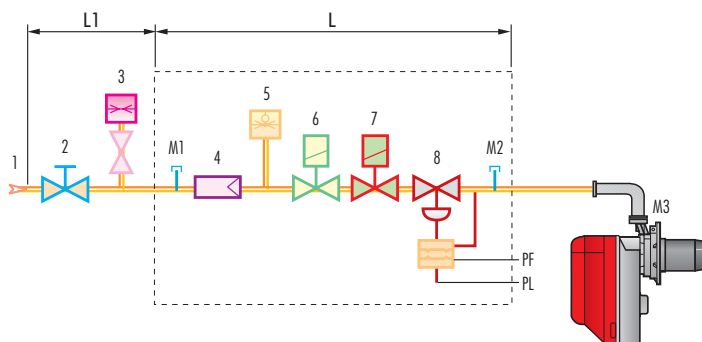

1	Gas supply pipe
2	Manual cock (charged to the installer)
3	Gas pressure gauge (charged to the installer)
4	Filter
5	Gas pressure switch
6	Electromagnetic safety valve
7	Electromagnetic operating valve
8	Pressure governor
PF	Pressure in combustion chamber
PL	Air pressure at combustion head
M1	Gas-supply pressure test point
M2	Pressure point for gas measurement at gas train outlet
M3	Pressure point for gas pressure measurement at combustion head

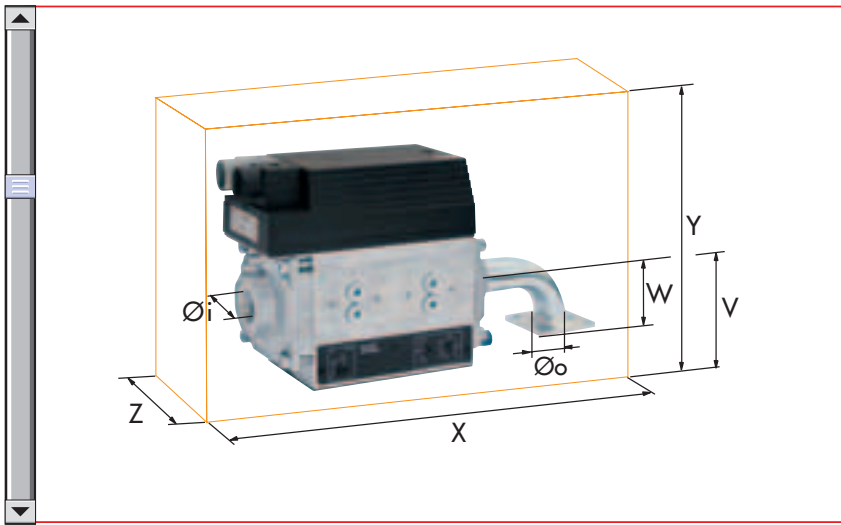

The dimensions of the gas trains vary depending on their construction features. The following table shows the dimensions of the gas trains that can be fitted to Gulliver BS/M burners, intake diameter and the coupling flange to the burner.

Name	Code	Burners	Ø i	Ø o	X mm	Y mm	W mm	Z mm	V mm
CG 120	3970587	BS2/M	3/4"	FLANGE 2	260	143	51	70	54
CG 220	3970588	BS3/M - BS4/M	3/4"	FLANGE 3	290	159	51	87	60





PRESSURE DROP DIAGRAM

The diagrams indicate the minimum pressure drop of the burners with the various gas trains that can be matched with them; the value thus calculated represents the minimum required input pressure to the gas train.

NATURAL GAS

LPG

BS2/M

BS2/M

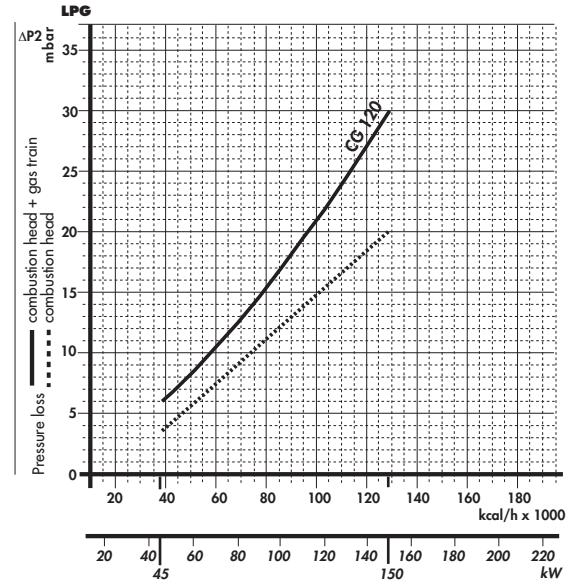
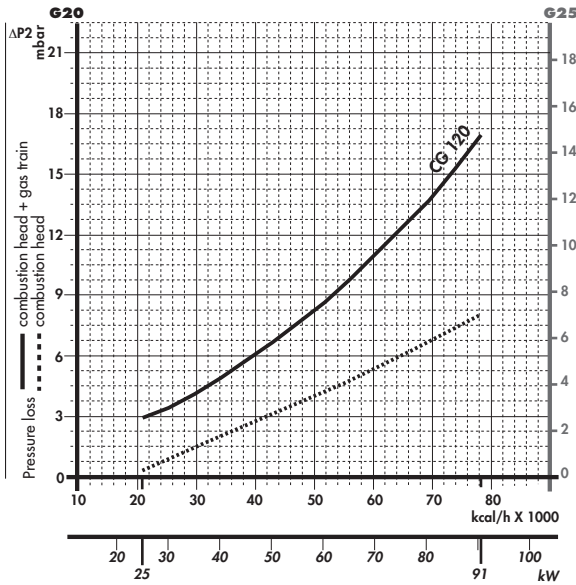

Gas Train	Code	Plug and socket
CG 120	3970587	•

NATURAL GAS

LPG

BS3/M

BS3/M

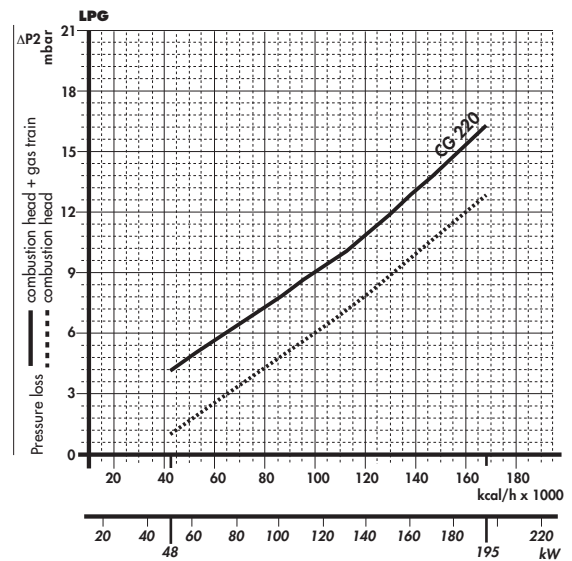
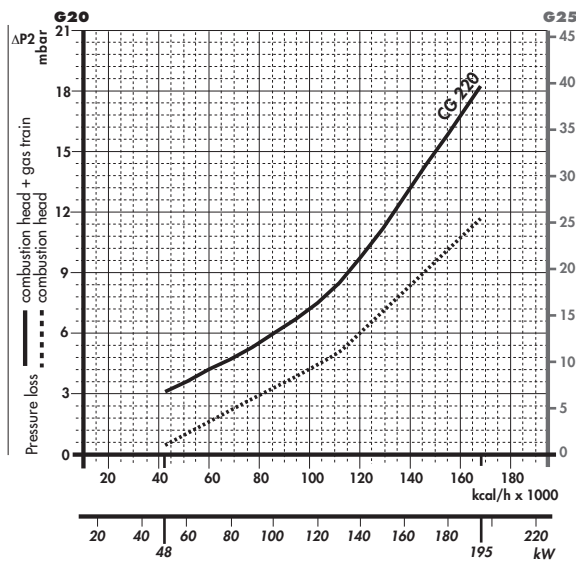

Gas Train	Code	Plug and socket
CG 220	3970588	•



NATURAL GAS

LPG

BS4/M

BS4/M

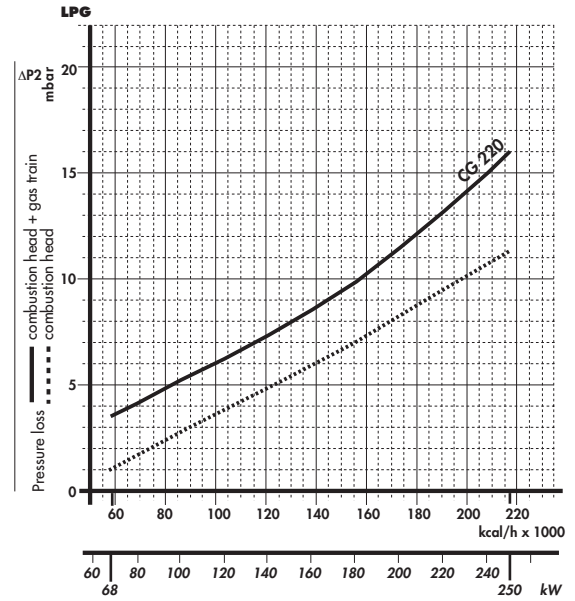
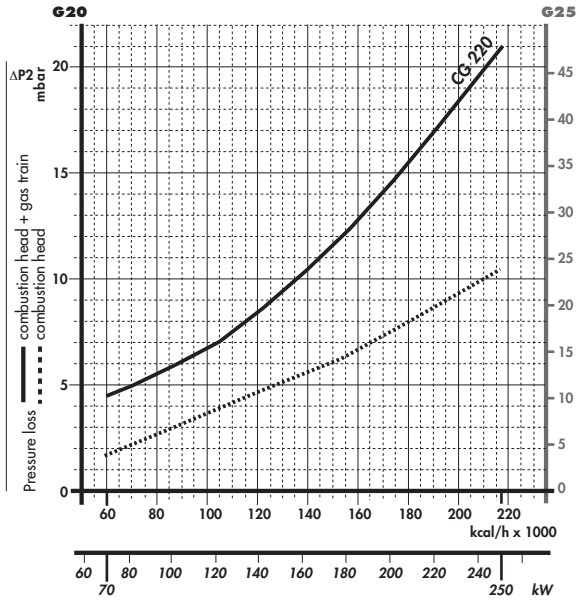

Gas Train	Code	Plug and socket
CG 220	3970588	•

note For pressure levels different from those indicated above, please contact Riello Burners Technical Office.



VENTILATION



The different ventilation circuits always ensure low noise levels with high performance of pressure and air delivery, in spite of their compact size.



Air suction



Air pressure switch

The burners are fitted with an adjustable air pressure switch, conforming to EN 676 standards.

COMBUSTION HEAD

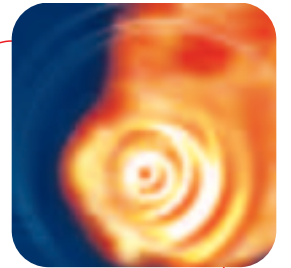

The combustion head in Gulliver BS/M burners is the result of an innovative design, which allows combustion with low polluting emissions, while being easy to adapt to all the various types of boilers and combustion chambers.

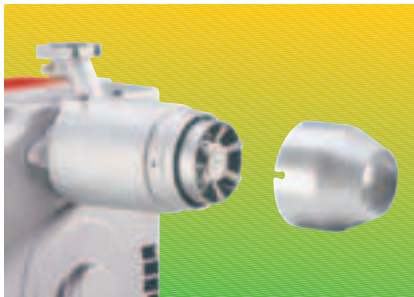

Combustion head



Mobile flange

Thanks to the use of a mobile coupling flange, the penetration of the head into the combustion chamber can be adjusted.

Simple adjustment allows the internal geometry of the combustion head to be adapted to the burner output.

Dimensions of the flame

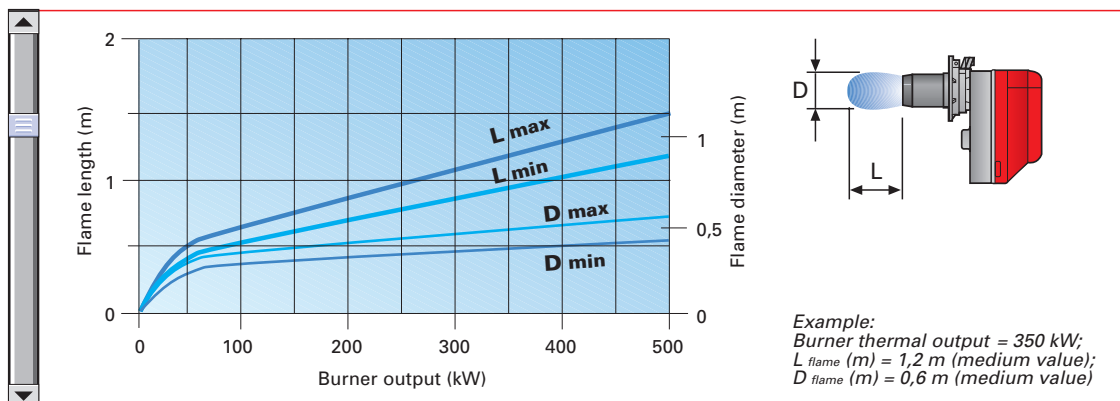



ADJUSTMENT

► BURNER OPERATION MODE

All these models are two stage operations.

The Gulliver BS/M series of two stage burners allows operating at both full and reduced output, with consequent reduction in turning the burner on and off, their giving better performance to the boiler.

During stand-by, the air damper is completely closed (controlled by an electric servomotor) and prevents heat loss due to the flue draught.

“Two stage progressive” operation

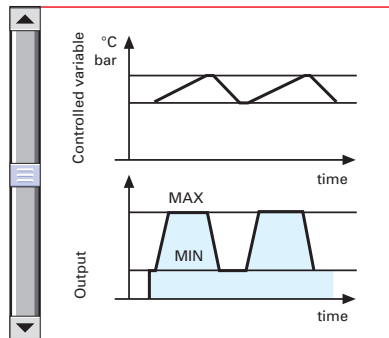

Figure A

“Modulating” operation

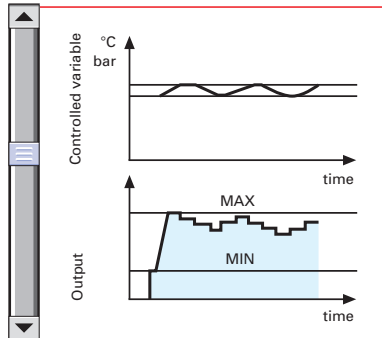
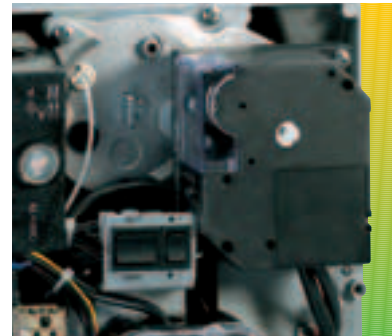
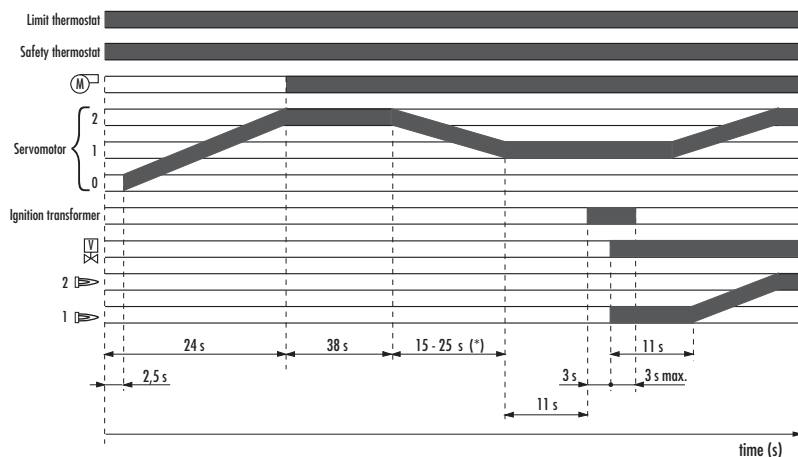

Figure B



Air regulation unit

► START UP CYCLE



0s	The burner begins the ignition cycle.
0s÷2,5s	Safety time.
2,5s÷26,5s	Progressive open of the air damper until the 2 nd stage position.
26,5s÷64,5s	Pre-purge at the 2 nd stage.
64,5s÷89,5s	The air damper closes until 1 st stage position.
89,5s÷100,5s	Pre-purge at the 1 st stage.
100,5s÷106,5s	The ignition transformer starts.
103,5s	The solenoid opens.
103,5s÷106,5s	Ignition 1 st stage.
106,5s÷114,5s	Working on 1 st stage.
114,5s	Progressive 2 nd stage startup.

(*) Change from 2nd stage to 1st stage happens in 25s.

WIRING DIAGRAMS

Electrical connections must be made by qualified and skilled personnel, in conformity with the local regulations in force. The 7-pole socket, the 4-pole socket (for connecting the 2nd stage thermostat to the hour meter or the output regulator) and the 6-pole socket (for the connection to the gas train) are connected to the equipment and fixed outside the burner. The terminal strip (for connecting the output regulator) is already connected to the equipment but fixed into the burner.

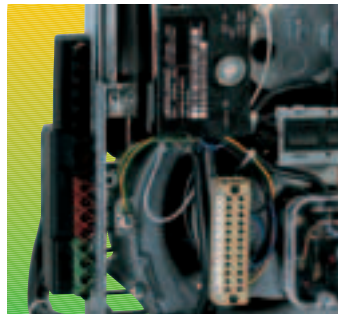
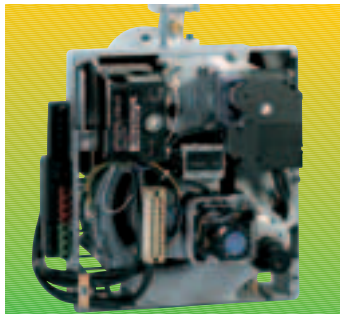

Pole socket and terminal strip

“TWO STAGE” PROGRESSIVE OPERATION

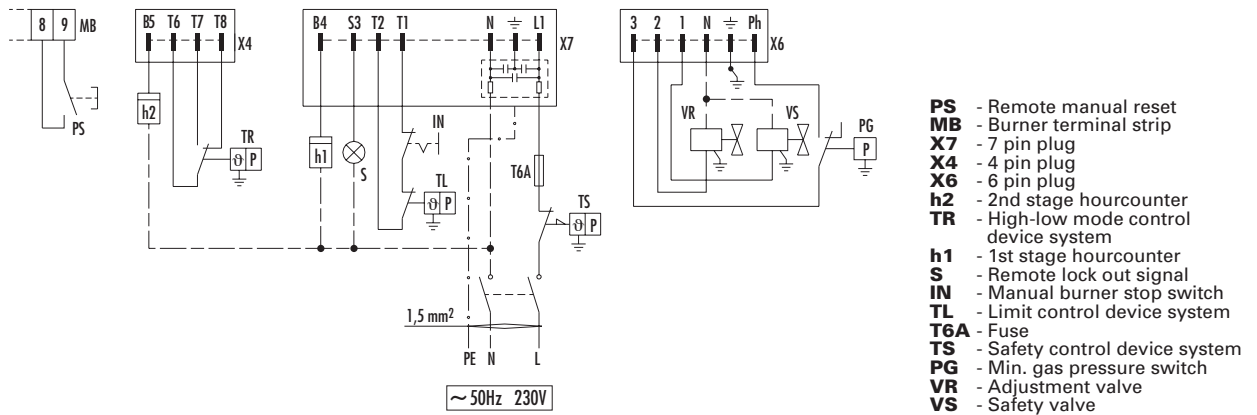

“MODULATING” OPERATION (with regulator)

- PS** - Remote manual reset
- MB** - Burner terminal strip
- X7** - 7 pin plug
- X4** - 4 pin plug
- BT** - Temperature probe
- BP** - Pressure probe

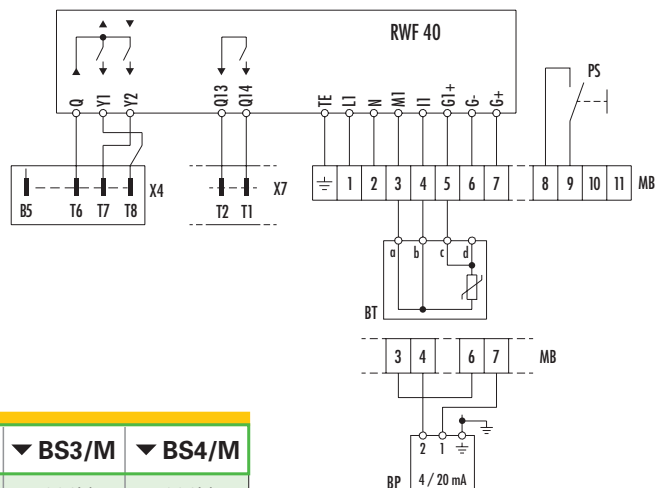

The following table shows the supply lead sections and types of fuse to be used.

Model	▼ BS2/M	▼ BS3/M	▼ BS4/M
F A	230V	230V	230V
L mm ²	T6	T6	T6
	1,5	1,5	1,5

F = Fuse

L = Lead section





EMISSIONS

The burners in the Gulliver BS/M series guarantee controlled combustion, reducing emissions of both CO and NOx. This combustion control is due to the recirculation of the combustion products in the chamber (thanks to different combustible air flow speeds) and to the fuel staging technique (thanks to the special geometry of the gas nozzles).

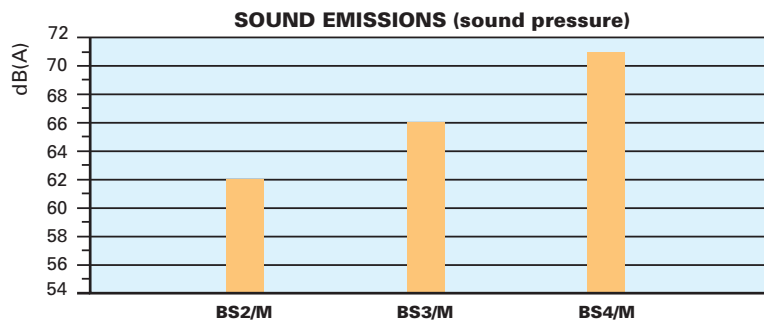
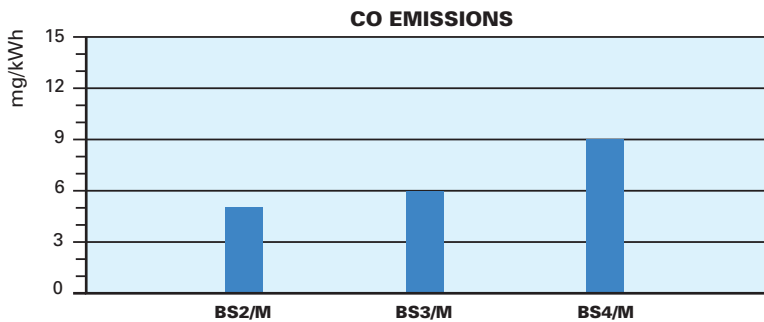
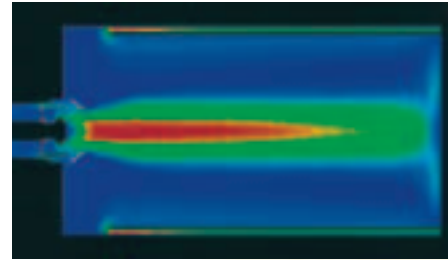
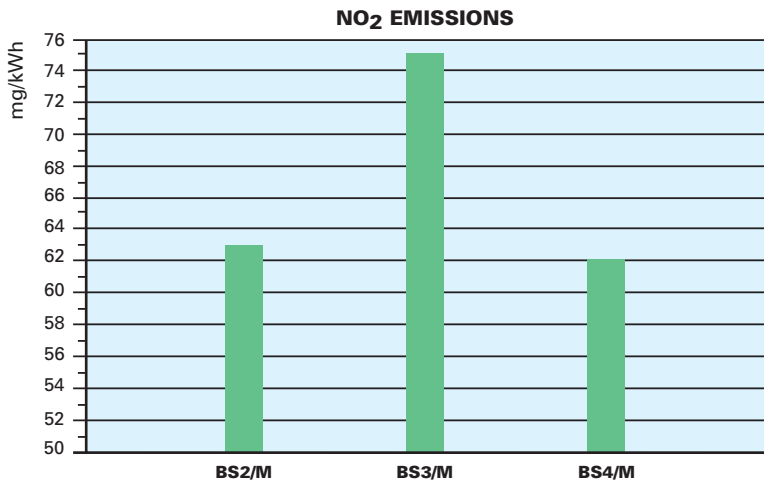

The emission data have been measured in the various models at maximum output, in conformity with EN 676 standard.

Special attention has been paid to noise reduction. All models are fitted with sound-proofing material inside the cover.



OVERALL DIMENSIONS (mm)



These models are distinguished by their reduced size, in relation to their output, which means they can be fitted to any boiler on the market.

BURNER

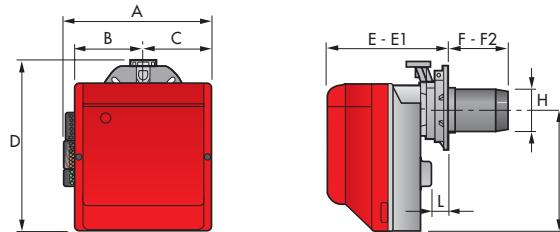

Model	A	B	C	D	E	E1	F	F2	H	I	L
▶ BS2/M	285	125,5	125,5	325	238	252	100	114	106	230	18
▶ BS3/M	330	150	150	391	262	280	110	128	129	285	21
▶ BS4/M	330	150	150	392	278	301	145	168	137	286	21

BURNER-BOILER MOUNTING FLANGE

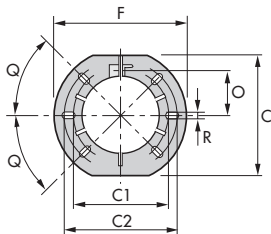

Model	C	C1	C2	F	O	Q	R
▶ BS2/M	167	140	170	192	66	45	11
▶ BS3/M	201	160	190	216	76,5	45	11
▶ BS4/M	203	170	200	218	80,5	45	11

PACKAGING

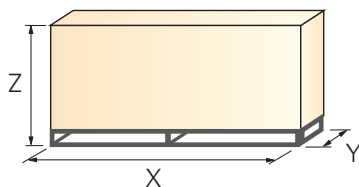

Model	X	Y	Z	kg
▶ BS2/M	395	318	365	12
▶ BS3/M	440	365	430	16
▶ BS4/M	500	365	430	18



INSTALLATION DESCRIPTION



Installation, start up and maintenance must be carried out by qualified and skilled personnel.

The burner is set in the factory on standard calibration (minimum output). If necessary adjustments can be made on the basis of the maximum output of the boiler. All operations must be performed as described in the technical handbook supplied with the burner.

- ▶ The mobile flange allows adapting the length of the combustion head to the combustion chamber (flame inversion or 3 smoke cycles) and to the thickness of the boiler panel.

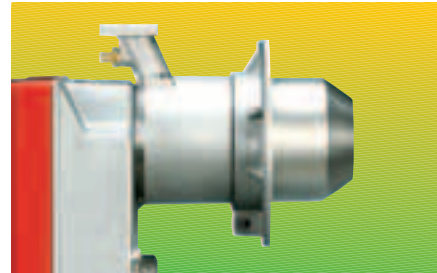

▶ **BURNER SETTING**

- ▶ The 1st stage and the 2nd stage air damper position can be easily carried out by setting the cam of the servomotor and following the manual instruction.



- ▶ Head setting is easy and aided by a graduated scale, a test point allows reading the air pressure in the combustion head.



- ▶ Gulliver BS/M burners are fitted with an air pressure switch which, in accordance with EN 676 standards, can be adjusted by the installer using a graduated selector, on the basis of the effective working conditions.

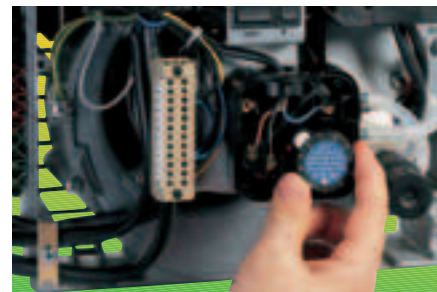

▶ **MAINTENANCE**

- ▶ Maintenance is easily solved because the combustion head can be disassembled without having to remove the burner and gas train from the boiler.



BURNER ACCESSORIES



Extended head kit

“Standard head” burners can be transformed into “extended head” versions by using the special kit. Below the KITS available for the various burners are listed, showing the original and the extended lengths.

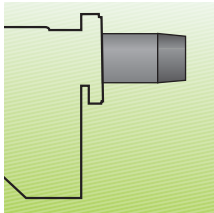

Extended head kit			
Burner	Standard head length (mm)	Extended head length (mm)	Kit Code
BS2/M (long)	100 ÷ 114	170 ÷ 180	3002722
BS2/M (extra long)	100 ÷ 114	270 ÷ 280	3002723
BS3/M	110 ÷ 128	267 ÷ 282	3002724
BS4/M	145 ÷ 168	302 ÷ 317	3002725

LPG kit

For burning LPG gas, a special kit is available to be fitted to the combustion head on the burner, as shown in the following table.



LPG kit		
Burner	Kit code for standard head	Kit code for extended head
BS2/M	3002711	3002711
BS3/M	3002712	3002712
BS4/M	3002713	3002713

Alternative combustion head kit

To extend the adaptability of Gulliver BS/M burners to any sort of application, alternative combustion heads have been developed, for example, to overcome situations of combustion instability which could arise with certain heat generators.

These heads cause a very limited increase in NOx emissions, due to the slower air flow.

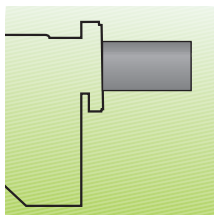

Alternative combustion head kit	
Burner	Kit Code
BS2/M	3001064
BS3/M	3001060
BS4/M	3001070

Ground fault interrupter kit

A “ground fault interrupter kit” is available as safety device in case of electrical system fault.



Ground fault interrupter kit	
Burner	Kit code
BS2/M - BS3/M - BS4/M	3001180



Accessories for modulating operation

To obtain modulating operation, the BS/M series of burners requires a regulator with three point outlet controls. The following table lists the accessories for modulating operation with their application range.



Burner	Regulator type	Regulator code
BS2/M - BS3/M - BS4/M	RWF 40	3001078

The relative temperature or pressure probes fitted to the regulator must be chosen on the basis of the application.



Probe type	Range (°C) (bar)	Probe code
Temperature PT 100	-100 ÷ 500°C	3010110
Pressure 4 ÷ 20 mA	0 ÷ 2,5 bar	3010213
Pressure 4 ÷ 20 mA	0 ÷ 16 bar	3010214

Depending on the servomotor fitted to the burner, a three-pole potentiometer (1000 W) can be installed to check the position of the servomotor.



Burner	Potentiometer kit code
BS2/M - BS3/M - BS4/M	3010109

7-pin plug kit

If necessary a 7-pin plug kit is available (in packaging of n. 5 pieces).

Burner	Kit code
BS2/M - BS3/M - BS4/M	3000945

SPECIFICATION



A special index guides your choice of boiler from the various models available in the BS/M series. Below there is a clear and detailed specification description of the product.

DESIGNATION OF SERIES

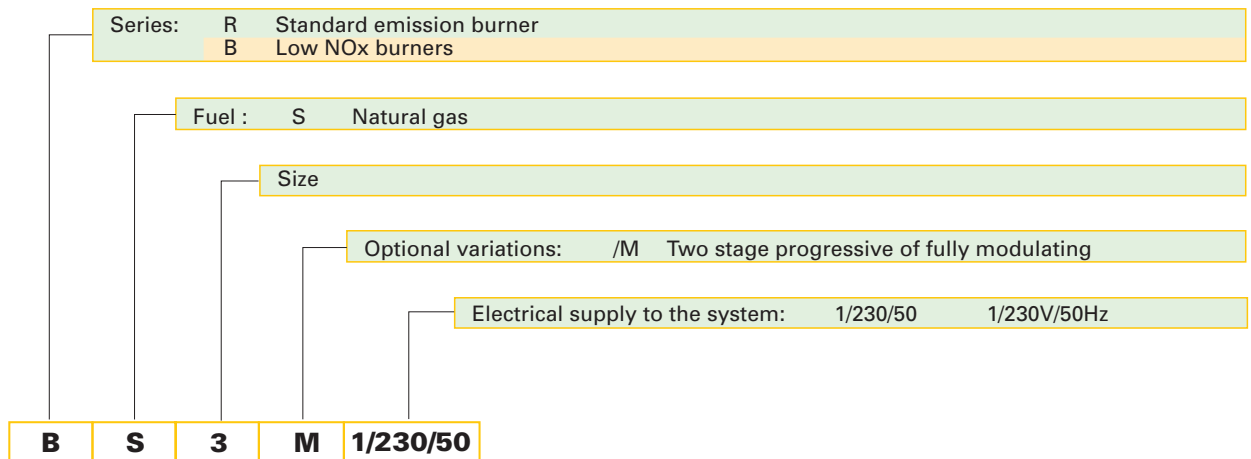

AVAILABLE BURNER MODELS

BS2/M 1/230/50
BS3/M 1/230/50
BS4/M 1/230/50



▶ PRODUCT SPECIFICATION

Burner

Monobloc, gas burners, completely automatic, high/low progressive operation mode or fully modulating by using a regulator:

- Fan with forward curve blades
- Cover lined with sound proofing material
- Digital control box
- Servomotor to drive the air damper to fully closed position at stand by, low and high fire position
- Single phase electric motor 230 V, 50 Hz
- Combustion head fitted with:
 - stainless steel head cone, resistant to high temperatures
 - ignition electrodes
 - ionisation probe
 - gas distributor
 - flame stability disk
- Flame inspection window
- Adjustable air pressure switch, with graduated selector, to guarantee burner lock out in the case of insufficient combustible air
- Protection filter against radio interference
- IP 40 electric protection level.

Gas train

Fuel supply line in the Multibloc configuration, fitted with:

- Filter
- Pressure stabiliser
- Minimum gas pressure switch
- Safety valve
- One stage working valve
- Self-adapting regulator, to adjust the gas flow following the air flow.

Approval

- EN 676 standard.

Conforming to European Directives

- 90/396/EEC (gas)
- 89/336/EEC (electromagnetic compatibility)
- 73/23/EEC (low voltage)
- 92/42/EEC (efficiency).

Standard equipment

- Flange with insulating gasket
- Screws and nuts for flange to be fixed to boiler
- Screw and nut for flange
- Blue plastic tube
- G 1/8 union elbow
- 4-pin plug
- 7-pin plug
- Instruction handbook for installation, use and maintenance
- Spare parts catalogue.

Available accessories to be ordered separately

- Extended head kit
- LPG kit
- Alternative combustion head kit
- Ground fault interrupter kit
- Accessories for modulating operation (RWF 40, temperature and pressure probe)
- Seal control kit.





RIELLO S.p.A. - Via degli Alpini, 1 - 37045 LEGNAGO (VR) Italy
Tel. ++39.0442630111 - Fax ++39.044221980

Internet: <http://www.rielloburners.com> - E-mail: info@rielloburners.com

Since the Company is constantly engaged in the production improvement, the aesthetic and dimensional features, the technical data, the equipment and the accessories can be changed.
This document contains confidential and proprietary information of RIELLO S.p.A.
Unless authorised, this information shall not be divulged, nor duplicated in whole or in part.

