

CE

**RIELLO**  
**B**  
**BURNERS**



**LOW NOX MODULATING DUAL FUEL BURNERS**

▶ **RLS/M MX SERIES**

▶ <b>RLS 68/M MX</b>	200/350 ÷ 860	kW
▶ <b>RLS 120/M MX</b>	300/600 ÷ 1200	kW
▶ <b>RLS 160/M MX</b>	300/930 ÷ 1840	kW



The RLS/M MX series of burners covers a firing range from 200 to 1840 kW, and they have been designed for use in hot or superheated water boilers, hot air or steam generators, diathermic oil boilers.

Operation is "two stage" at the oil side and "modulating" at the gas side with the installation of a PID logic regulator and respective probes.

RLS/M MX series burners guarantees high efficiency levels in all the various applications, thus reducing fuel consumption and running costs.

Optimisation of sound emissions is guaranteed by the special design of air suction circuit and the use of sound proofing material.

The exclusive design ensures reduced dimensions, simple use and maintenance. A wide range of accessories guarantees elevated working flexibility.

## TECHNICAL DATA

Model			▼ RLS 68/M MX	▼ RLS 120/M MX	▼ RLS 160/M MX
Burner operation mode			two stages light oil - two stages progressive/modulating gas		
Modulation ratio at max. output			1 ÷ 2 (light oil) / 1 ÷ 4 (gas)		
Servomotor	run time	type	SQN 31		
		s	33		
Heat output		kW	200/350-860	300/600-1200	300/930-1840
		Mcal/h	172/300-740	258/516-1032	258/800-1582
Working temperature		°C min./max.	0/40		
Oil	net calorific value	kWh/kg	11,86		
	viscosity	mm <sup>2</sup> /s (cSt)	4 ÷ 6		
	delivery	kg/h	17/30-73	25/50-101	25/78-155
Pump		type	J6 C		J7 C
	delivery	kg/h	230 (at 12 bar)		
Atomised pressure		bar	12		
Fuel temperature		max. °C	60		
Fuel pre-heater			NO		
G20	net calorific value	kWh/Nm <sup>3</sup>	10		
	density	kg/Nm <sup>3</sup>	0,71		
	gas delivery	Nm <sup>3</sup> /h	23/35-86	30/60-120	30/93-184
G25	net calorific value	kWh/Nm <sup>3</sup>	8,6		
	density	kg/Nm <sup>3</sup>	0,78		
	gas delivery	Nm <sup>3</sup> /h	27/40-100	35/70-140	35/108-214
LPG	net calorific value	kWh/Nm <sup>3</sup>	25,8		
	density	kg/Nm <sup>3</sup>	2,02		
	gas delivery	Nm <sup>3</sup> /h	--		
Fan		type	reverse blade fan		straight blade fan
Air temperature		max °C	60		
Electrical supply		Ph/Hz/V	3N/50/230-400~(±10%)		
Auxiliary electrical supply		Ph/Hz/V	1/50/230~(±10%)		
Control box		type	LFL 1.333 (FS1) - LGK 16 (FS2)		
Total electrical power		kW	3	3,7	6,0
Auxiliary electrical power		kW	1,5		
Heaters electrical power		kW	--		
Protection level		IP	44		
Pump motor electrical power		kW	0,55		
Rated pump motor current		A	3,6		
Pump motor start up current		A	9,5		
Pump motor protection level		IP	44		
Fan motor electrical power		kW	1,5	2,2	4,5
Rated fan motor current		A	5,9 - 3,4	8,8 - 5,1	15,8 - 9,1
Fan motor start up current		A	35,4 - 20	52,8 - 30,6	126 - 72,8
Fan motor protection level		IP	54		
Ignition transformer		type	--		
		V1 - V2	230V - 2x5 kV		
		I1 - I2	1,9A - 30mA		
Operation			FS1 intermittent (1 stop each 24 h) - FS2 continuous (1 stop each 72 h)		
Sound pressure		dB (A)	76	79	80,5
Sound power		W	--		
Oil	CO emission	mg/kWh	< 10		
	grade of smoke indicator	N° Bacharach	< 1		
	CxHy emission	mg/kWh	< 10		
	NOx emission	mg/kWh	< 185		
G20	CO emission	mg/kWh	< 10		
	NOx emission	mg/kWh	< 80		
Directive			909/396 - 88/336 - 72/23 EEC		
Conforming to			EN 267 - EN 676		
Certification			CE 0085BP0175		CE 0085BN0625

Reference conditions: Temperature: 20°C - Pressure: 1000 mbar - Altitude: 100 m a.s.l. - Noise measured at a distance of 1 meter.

Since the Company is constantly engaged in the production improvement, the aesthetic and dimensional features, the technical data, the equipment and the accessories can be changed.  
This document contains confidential and proprietary information of RIELLO S.p.A. Unless authorised, this information shall not be divulged, nor duplicated in whole or in part.



# FIRING RATES

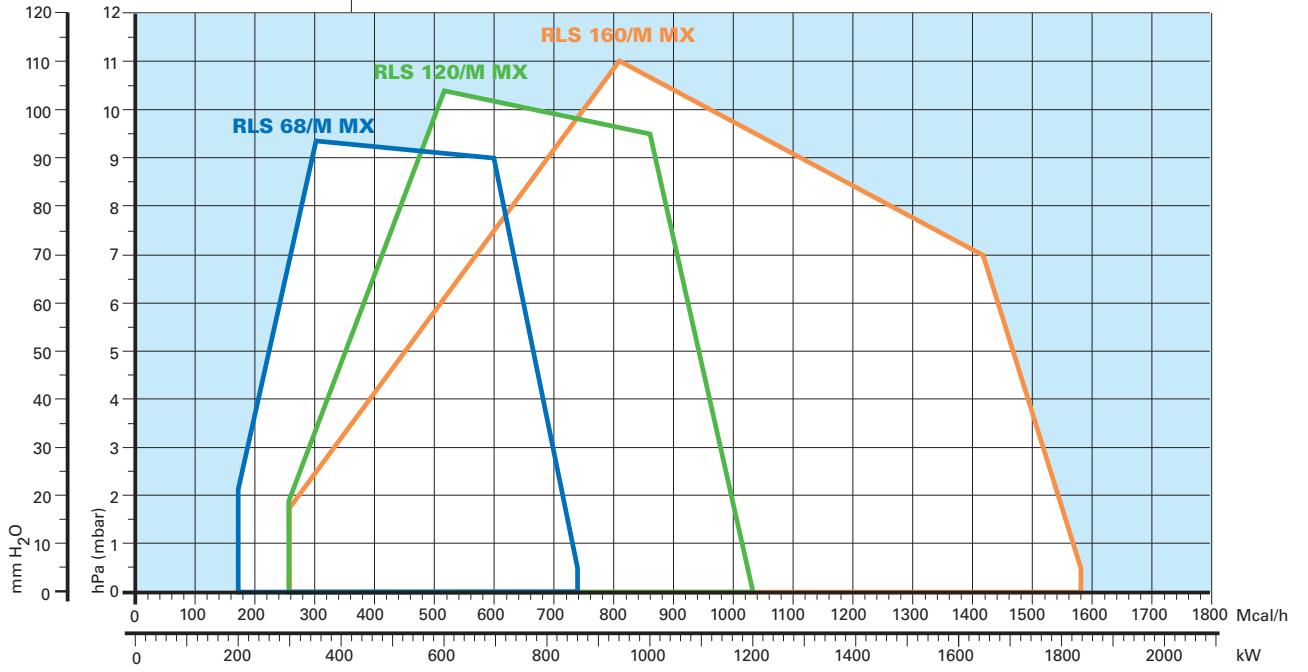

Useful working field for choosing the burner

Modulation range

**Test conditions conforming to EN 267 - EN 676:**

Temperature: 20°C  
 Pressure: 1000 mbar  
 Altitude: 100 m a.s.l.





# FUEL SUPPLY

## GAS TRAIN

The burners are fitted with a butterfly valve to regulate the fuel, controlled by a variable profile cam servomotor. Fuel can be supplied either from the right or left hand sides. A maximum gas pressure switch stops the burner in case of excess pressure in the fuel line.

The gas train can be selected to best fit system requirements depending on the fuel output and pressure in the supply line.

The gas train can be "Multibloc" type (containing the main components in a single unit) or "Composed" type (assembly of the single components).

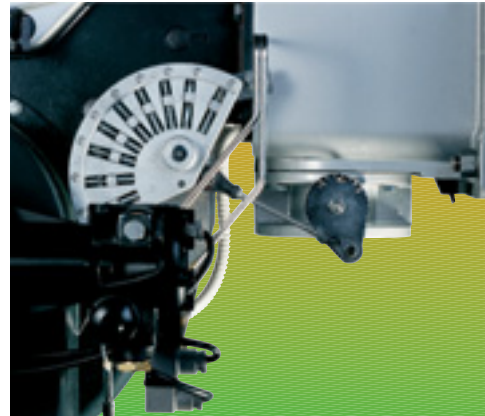

Example of the variable profile cam

### MULTIBLOC gas train type MBD 420

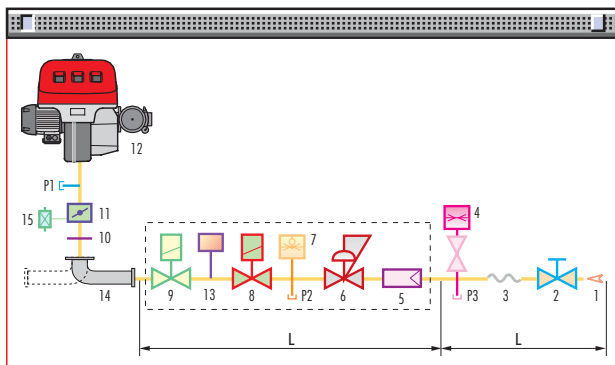

### MULTIBLOC gas train type MBC 1200

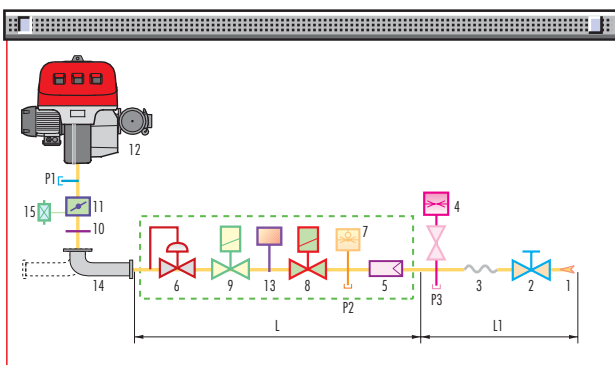

### COMPOSED gas train type MBC 1900-3100

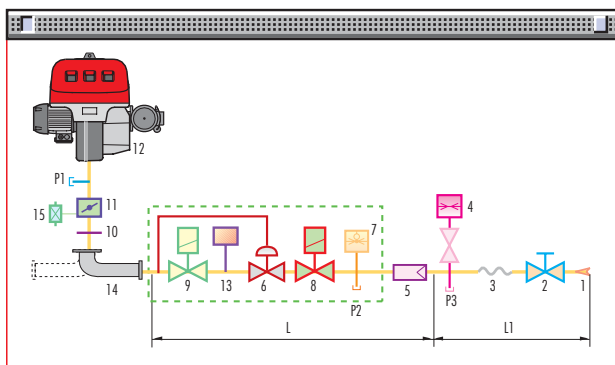

1	Gas input pipework
2	Manual valve
3	Anti-vibration joint
4	Pressure gauge with pushbutton cock
5	Filter
6	Pressure regulator (vertical)
7	Minimum gas pressure switch
8	VS safety solenoid (vertical)
9	VR regulation solenoid (vertical) Two settings: - firing output (rapid opening) - maximum output (slow opening)
10	Gasket and flange supplied with the burner
11	Gas adjustment butterfly valve
12	Burner
13	Seal control mechanism for valves 8-9. According to standard EN 676, the seal control is compulsory for burners with maximum output above 1200 kW (in gas train with seal control)
14	Gas train-burner adapter
15	Maximum gas pressure switch
P1	Combustion head pressure
P2	Pressure downstream from the regulator
P3	Pressure upstream from the filter
L	Gas train supplied separately, with the code given in the table
L1	Installer's responsibility

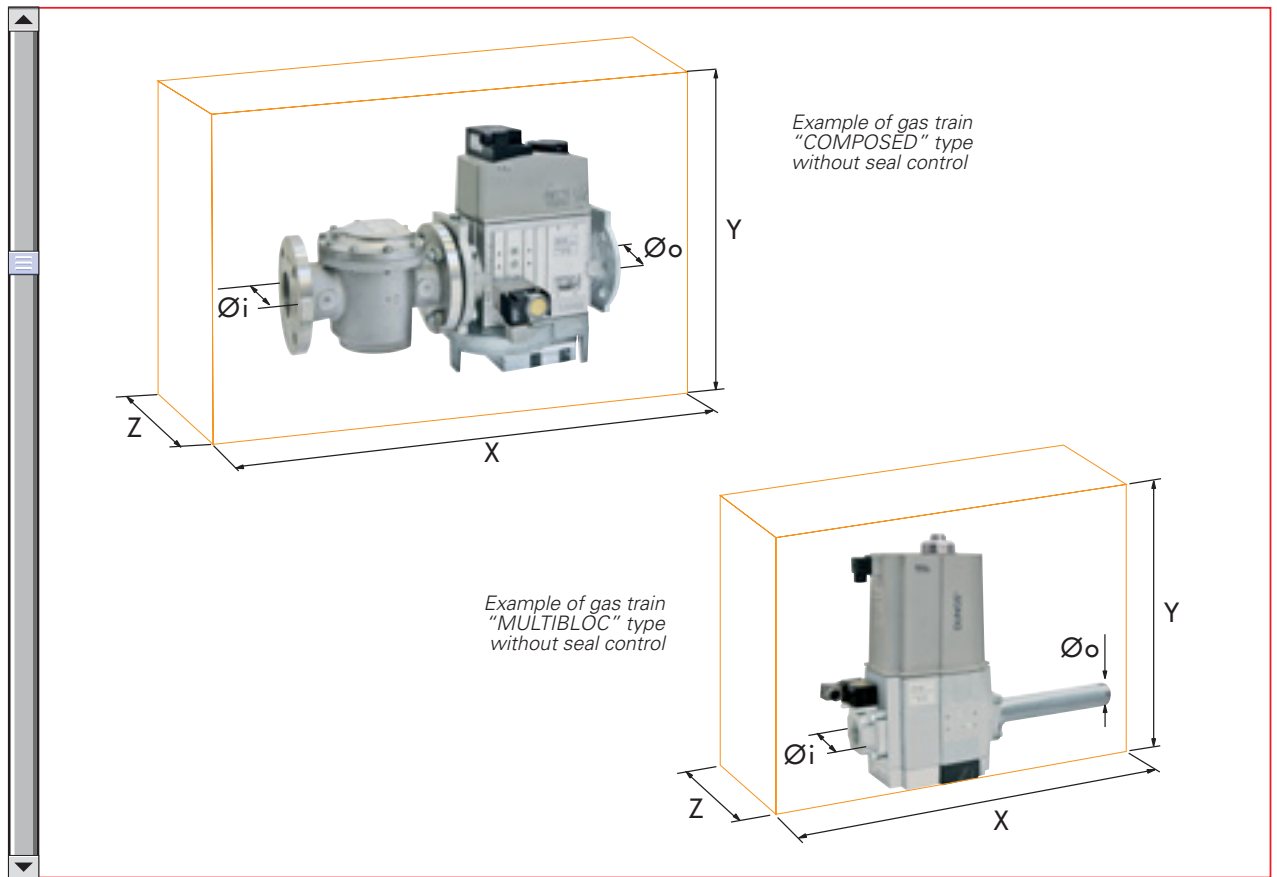

Gas trains are approved by standard EN 676 together with the burner.

The overall dimensions of the gas train depends on how they are constructed. The following table shows the maximum dimensions of the gas trains that can be fitted to RLS/M MX burners, intake and outlet diameters and seal control if fitted.

Please note that the seal control can be installed as an accessory, if not already installed on the gas train.

The maximum gas pressure of gas train "Multibloc" type is 360 mbar, and that one of gas train "Composed" type is 500 mbar.

The range of pressure towards the burner in the MULTIBLOC with flange can be modified choosing the stabiliser spring (see gas train accessory).

	Name	Code	Ø i	Ø o	X mm	Y mm	Z mm	Output pressure range mbar	Seal Control
<b>MULTIBLOC GASTRAINS</b>	<b>MBD 420</b>	3970181	2"	2"	523	100	300	4-33	Accessory
	<b>MBD 420 CT</b>	3970182	2"	2"	523	227	300	4-33	Incorporated
	<b>MBC 1200 SE 50</b>	3970221	2"	2"	573	425	161	4-60	Accessory
	<b>MBC 1200 SE 50 CT</b>	3970225	2"	2"	573	426	290	4-60	Incorporated
<b>COMPOSED GASTRAINS</b>	<b>MBC 1900 SE 65 FC</b>	3970222	DN 65	DN 65	583	430	237	20-40	Accessory
	<b>MBC 1900 SE 65 FC CT</b>	3970226	DN 65	DN 65	583	430	300	20-40	Incorporated
	<b>MBC 3100 SE 80 FC</b>	3970223	DN 80	DN 80	633	500	240	20-40	Accessory
	<b>MBC 3100 SE 80 FC CT</b>	3970227	DN 80	DN 80	633	500	320	20-40	Incorporated







## ► PRESSURE DROP DIAGRAM

The diagrams indicate the minimum pressure drop of the burners with the various gas trains that can be matched with them; at the value of these pressure drop add the combustion chamber pressure.

The value thus calculated represents the minimum required input pressure to the gas train.

### NATURAL GAS

#### RLS 68/M MX

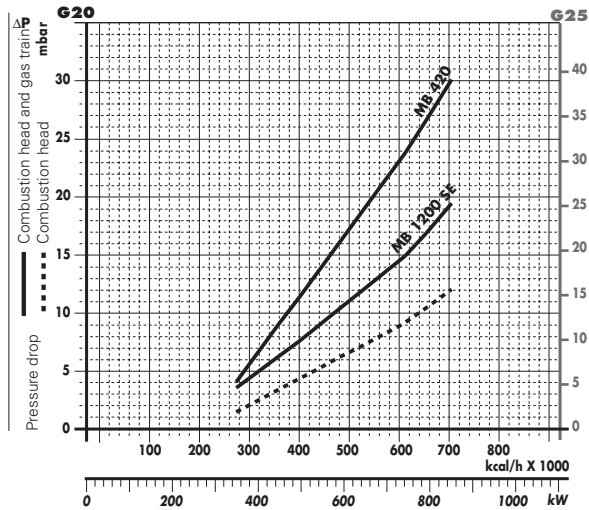

Gas train	Code	Adapter	Seal Control
MBD 420	3970181	-	Accessory
MBD 420 CT	3970182	-	Incorporated
MBC 1200 SE 50	3970221	-	Accessory
MBC 1200 SE 50 CT	3970225	-	Incorporated

#### RLS 120/M MX

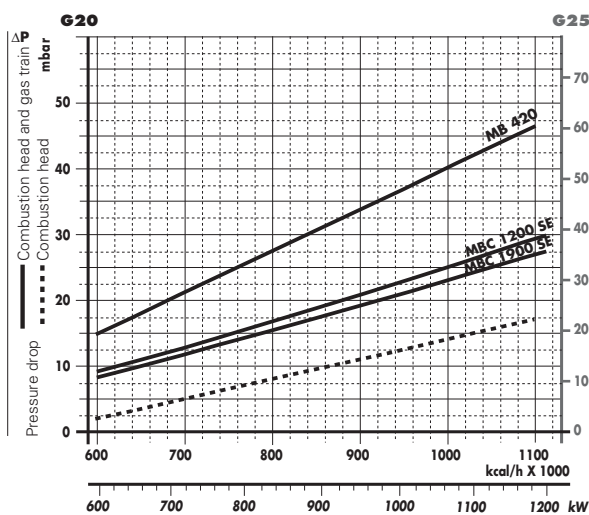

Gas train	Code	Adapter	Seal Control
MBD 420	3970181	-	Accessory
MBD 420 CT	3970182	-	Incorporated
MBC 1200 SE 50	3970221	-	Accessory
MBC 1200 SE 50 CT	3970225	-	Incorporated
MBC 1900 SE 65 FC	3970222	3000825	Accessory
MBC 1900 SE 65 FC CT	3970226	3000825	Incorporated

#### RLS 160/M MX

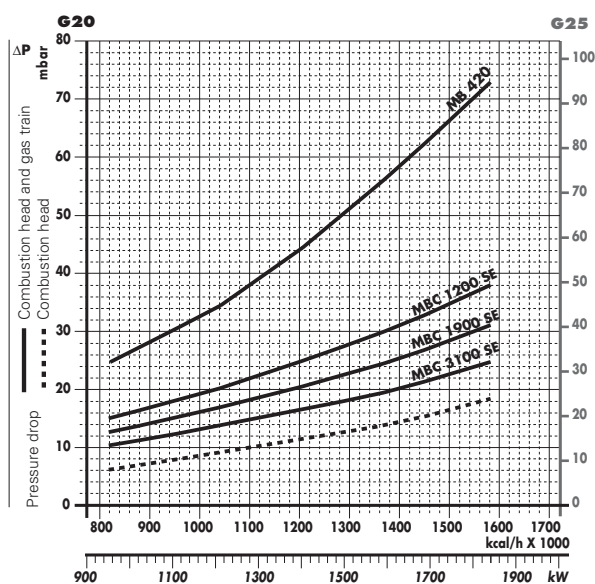

Gas train	Code	Adapter	Seal Control
MBD 420	3970181	-	Accessory
MBD 420 CT	3970182	-	Incorporated
MBC 1200 SE 50	3970221	-	Accessory
MBC 1200 SE 50 CT	3970225	-	Incorporated
MBC 1900 SE 65 FC	3970222	3000825	Accessory
MBC 1900 SE 65 FC CT	3970226	3000825	Incorporated
MBC 3100 SE 80 FC	3970223	3000826	Accessory
MBC 3100 SE 80 FC CT	3970227	3000826	Incorporated

► **note** Please contact the Riello Burner Technical Office for different pressure levels from those above indicated and refer to the technical manual for the correct choice of the spring.

MBC 1200 gas train: the minimum operating pressure (\*) is higher or equal to 10 mbar. The gas train has to be installed next to the burner (if needed, only with the adapters listed in the catalogue) and it has to operate in its own working field.

MBC 1900-3100 gas train: the minimum operating pressure (\*) is higher or equal to 15 mbar. The gas train has to be installed next to the burner (if needed, with the adapters listed in the catalogue) and it has to operate in its own working field.

(\*) it is the upstream gas train pressure in full load operation conditions.

## SELECTING THE FUEL SUPPLY LINES

The following diagram enables pressure drop in a pre-existing gas line to be calculated and to select the correct gas train.

The diagram can also be used to select a new gas line when fuel output and pipe length are known. The pipe diameter is selected on the basis of the desired pressure drop. The diagram uses methane gas as reference; if another gas is used, conversion coefficient and a simple formula (on the diagram) transform the gas output to a methane equivalent (refer to figure A). Please note that the gas train dimensions must take into account the back pressure of the combustion chamber during operations.

### Control of the pressure drop in an existing gas line or selecting a new gas supply line.

The methane output equivalent is determined by the formula fig. A on the diagram and the conversion coefficient.

Once the equivalent output has been determined on the delivery scale ( $\dot{V}$ ), shown at the top of the diagram, move vertically downwards until you cross the line that represents the pipe diameter; at this point, move horizontally to the left until you meet the line that represents the pipe length.

Once this point is established you can verify, by moving vertically downwards, the pipe pressure drop on the bottom scale below (mbar).

By subtracting this value from the pressure measured on the gas meter, the correct pressure value will be found for the choice of gas train.

**Example:**

- gas used G25
- gas output 9.51 mc/h
- pressure at the gas meter 20 mbar
- gas line length 15 m
- conversion coefficient 0.62 (see figure A)

$$\text{- equivalent methane output } \dot{V} = \left[ \frac{9.51}{0.62} \right] = 15.34 \text{ mc/h}$$

- once the value of 15.34 has been identified on the output scale ( $\dot{V}$ ), moving vertically downwards you cross the line that represents 1" 1/4 (the chosen diameter for the piping);

- from this point, move horizontally to the left until you meet the line that represents the length of 15 m of the piping;

- move vertically downwards to determine a value of 1.4 mbar in the pressure drop bottom scale;

- subtract the determined pressure drop from the meter pressure, the correct pressure level will be found for the choice of gas train;

- correct pressure = ( 20-1.4 ) = 18.6 mbar

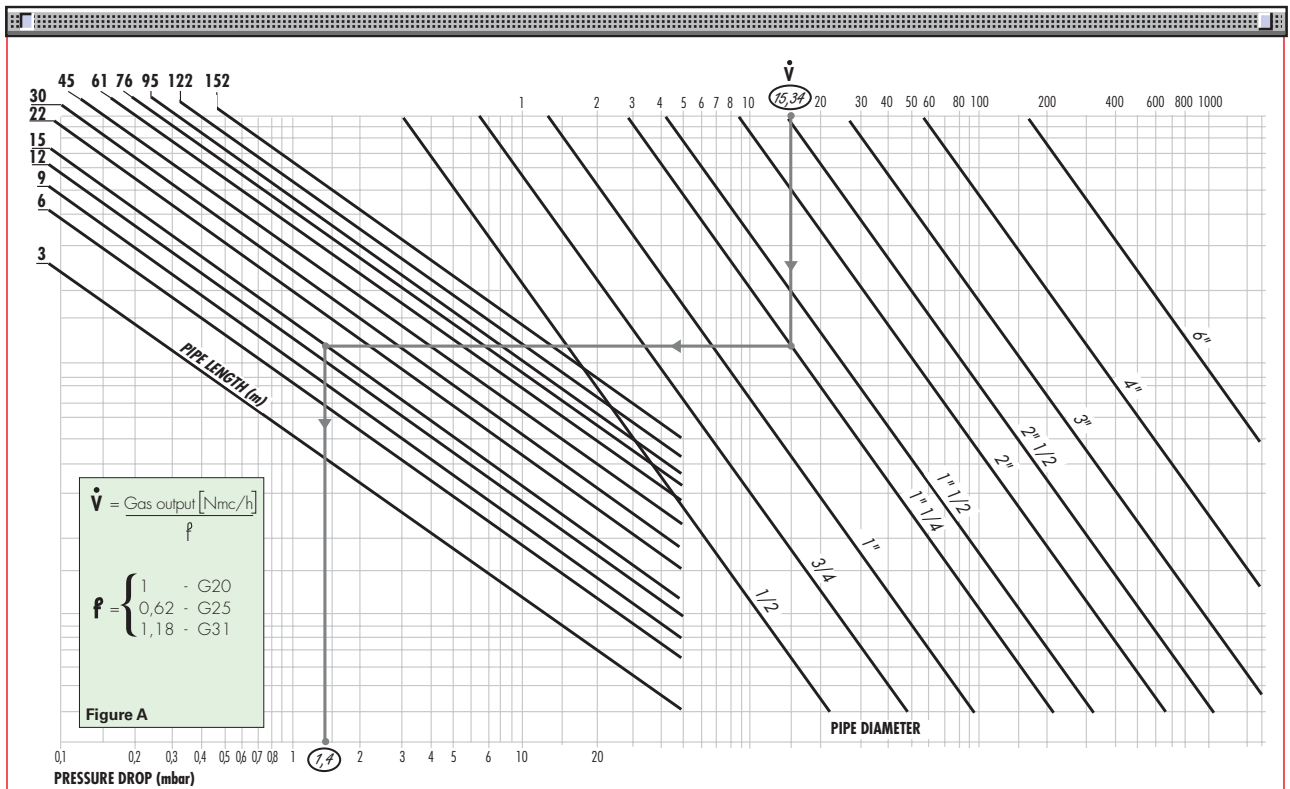

## ► HYDRAULIC CIRCUIT

The burners are fitted with three valves (a safety valve and two oil delivery valves) along the oil line from the pump to the nozzle.

A thermostatic control device, on the basis of required output, regulates oil delivery valves opening, allowing light oil passage through the valves and to the nozzle. Delivery valves open contemporary to the air damper opening, controlled by a servomotor.

The pumping group is fitted with a pump, an oil filter and a regulating valve: through this it is possible to manually adjust atomised pressure, which in factory is preset at 12 bar.



Example of light oil pump of RLS 160/M MX burner

### RLS/M MX

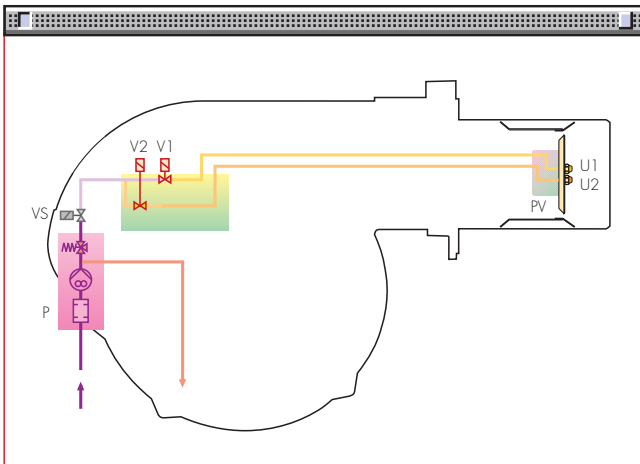

P	Pump with filter and pressure regulator on the output circuit
VS	Safety valve on the output circuit
V1	1st stage valve
V2	2nd stage valve
PV	Nozzle holder
U1	1st stage nozzle
U2	2nd stage nozzle





## SELECTING THE FUEL SUPPLY LINES

The fuel feed must be completed with the safety devices required by the local norms.

The table shows the choice of piping diameter, depending on the difference in height between the burner and the tank and their distance.

MAXIMUM EQUIVALENT LENGTH FOR THE PIPING L[m]			
Model	▼ RLS 160/M MX		
Diameter piping	Ø12mm	Ø14mm	Ø16mm
+H, -H (m)	L <sub>max</sub> (m)	L <sub>max</sub> (m)	L <sub>max</sub> (m)
+4,0	71	138	150
+3,0	62	122	150
+2,0	53	106	150
+1,0	44	90	150
+0,5	40	82	150
0	36	74	137
-0,5	32	66	123
-1,0	28	58	109
-2,0	19	42	81
-3,0	10	26	53
-4,0	-	10	25

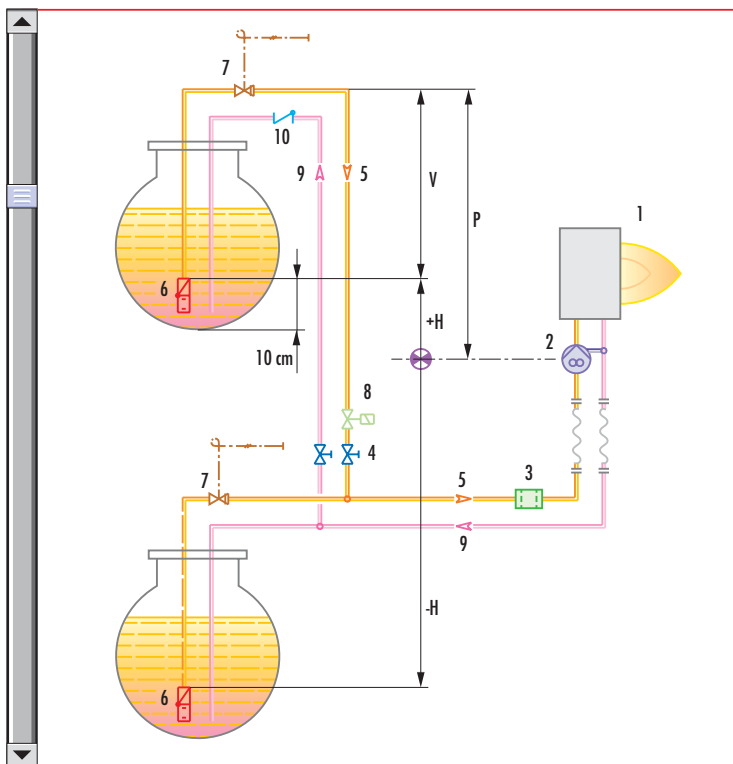

H	Difference in height pump-foot valve
Ø	Internal pipe diameter
P	Max. height 10 m
V	Height 4 m
1	Burner
2	Burner pump
3	Filter
4	Manual shut off valve
5	Suction pipework
6	Bottom valve
7	Remote controlled rapid manual shut off valve (compulsory in Italy)
8	Type approved shut off solenoid valve (compulsory in Italy)
9	Return pipework
10	Check valve

**note** With ring distribution oil systems, the feasible drawings and dimensioning are the responsibility of specialised engineering studios, who must check compatibility with the requirements and features of each single installation.





## VENTILATION

The ventilation circuit produces low noise levels with high performances pressure and air output, in despite of the compact dimensions. The special design of the air suction circuit and the use of sound-proofing material keeps noise level very low. A variable profile cam connects the fuel and air regulations, ensuring high fuel efficiency at all firing ranges. A minimum air pressure switch stops the burner when there is an insufficient quantity of air at the combustion head.



Example of the servomotor for air/gas setting



## COMBUSTION HEAD

Different lengths of the combustion head can be chosen for the RLS/M MX series of burners. The choice depends on the thickness of the front panel and the type of boiler. Depending on the type of generator, check that the penetration of the head into the combustion chamber is correct. The internal positioning of the combustion head can easily be adjusted to the maximum defined output by adjusting a screw fixed to the flange.

**note** The burners of RLS/M MX series are not suitable to be installed on boiler with "reverse flame chamber".



Example of RLS 160/M MX burner combustion head.

### Flame dimensions

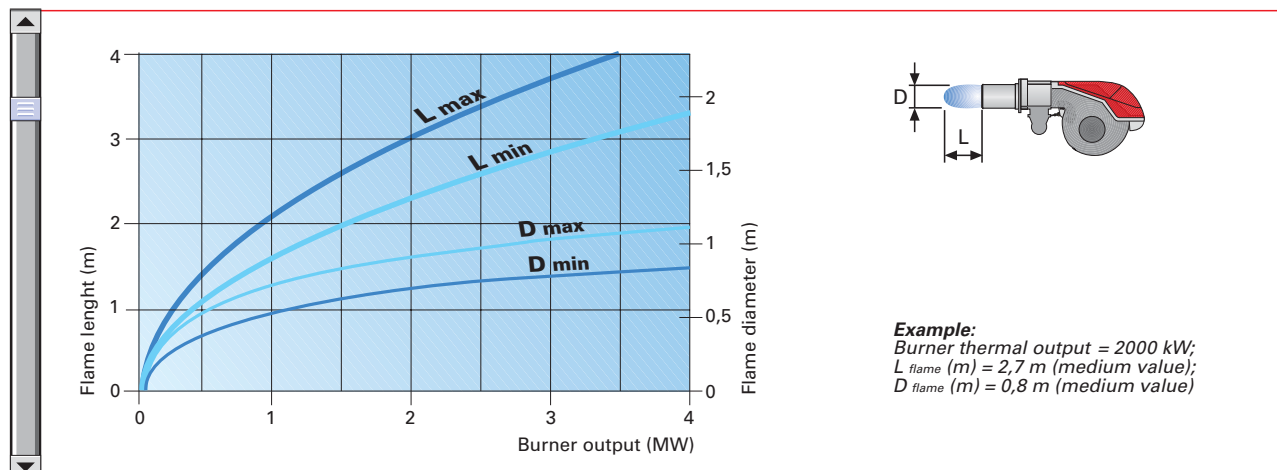

# ADJUSTMENT



## BURNER OPERATION MODE

The RLS/M MX series of burners can have "two stage" operation at the oil side and "modulating" operation at the gas side with the installation of a PID logic regulator and respective probes. When burner is supplied with light oil a modulation ratio of 2:1 is reached thanks to the "two nozzles" solution; when burner is supplied with gas modulation ratio is 6:1. The air is adapted to the servomotor rotations.

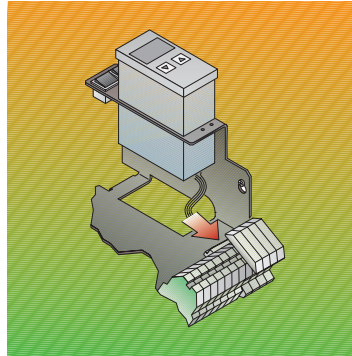

Example of a regulator

On "two stage" operation, the burner gradually adjusts output to the requested level, by varying between the two pre-set levels (see picture A).

### "Two stage" operation

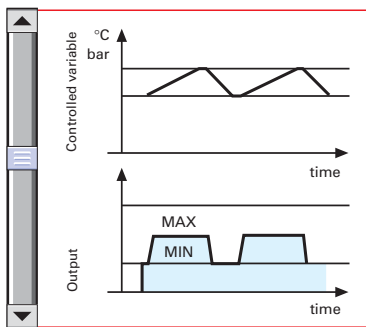

Picture A

### "Modulating" operation

In "modulating" operation, normally required in steam generators, in superheated boilers or diathermic oil burners, a specific regulator and probes are required. These are supplied as accessories that must be ordered separately. The burner can work for long periods at intermediate output levels (see picture B).

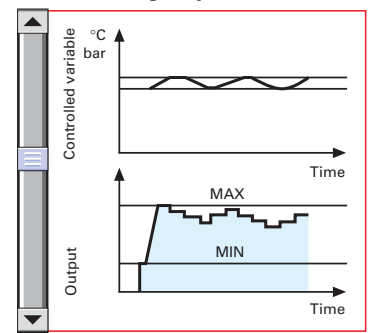

Picture B

## START UP CYCLE

- 0" Thermostat closes. The motor starts running.
- 6"-39" The servomotor opens the air damper.
- 39"-42" Pre-purge with air damper open.
- 42"-67" The servomotor takes the air damper to the firing position.
- 70" Pre-ignition
- 76" Solenoid security valve VS and V1 1st stage valve open; 1st stage flame
- 79" After 3" firing the ignition transformer switches off (if flame is detected, otherwise there is a lock-out)
- 88" If heat request is not yet satisfied, 2nd stage solenoid valve V2 opens and at the same time servomotor open completely the air damper. The starting cycle comes to an end. 2nd stage flame.

### RLS 68-120-160/M MX

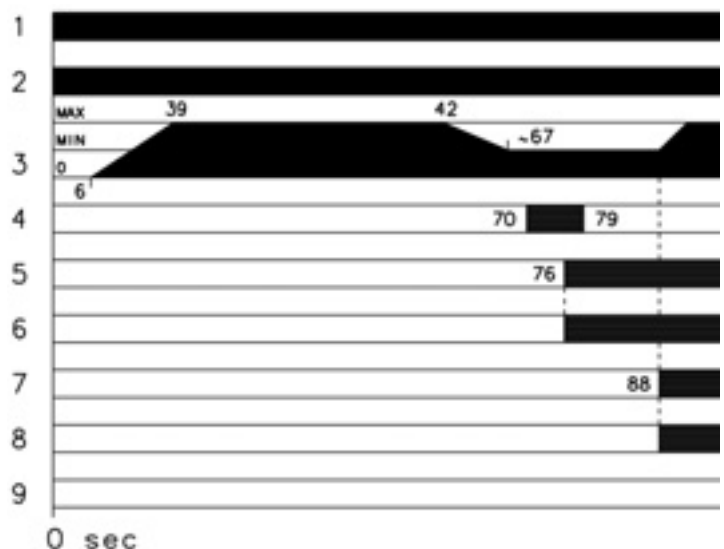

# WIRING DIAGRAMS



Electrical connections must be made by qualified and skilled personnel, according to the local regulations.



Example of the terminal board for electrical connections for the RLS/M MX model

## TWO STAGE PROGRESSIVE OPERATION

### RLS/M MX without seal control

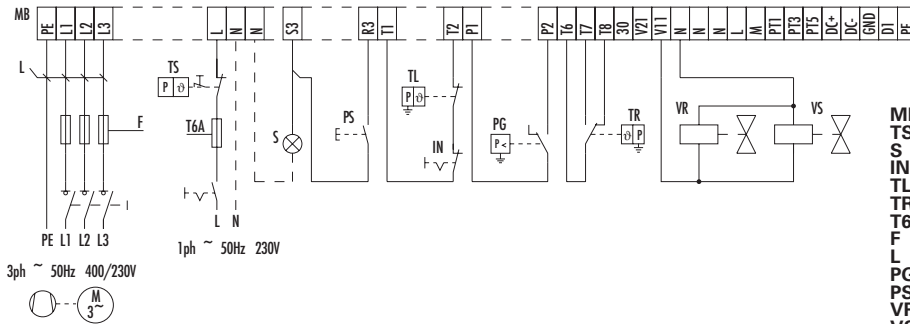

- MB** - Burner terminal board
- TS** - Safety thermostat
- S** - External lock-out signal
- IN** - Manual switch
- TL** - Threshold thermostat
- TR** - High/low flame setting thermostat
- T6A** - 6A fuse
- F** - Fuse (see table A)
- L** - Lead section (see table A)
- PG** - Minimum gas pressure switch
- PS** - Lock-out reset button
- VR** - Adjustment valve
- VS** - Safety valve

### RLS/M MX with seal control

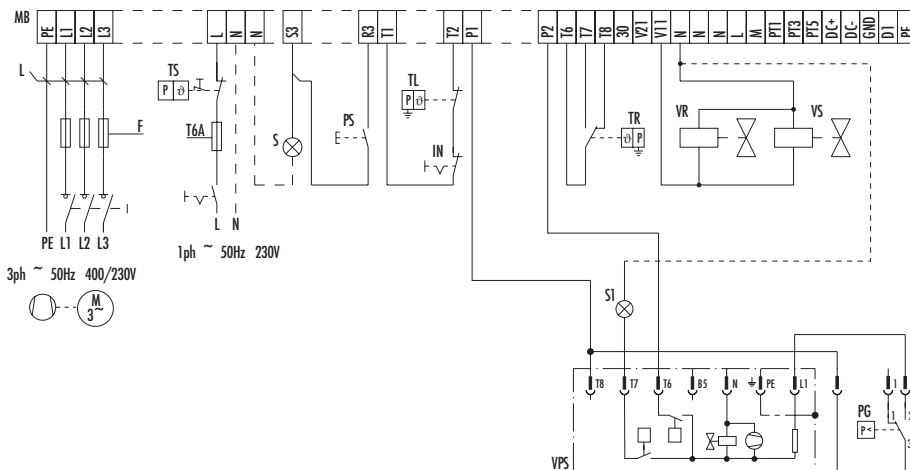

- MB** - Burner terminal board
- TS** - Safety thermostat
- S** - External lock-out signal
- S1** - External lock-out signal on the seal control
- IN** - Manual switch
- TL** - Threshold thermostat
- TR** - High/low flame setting thermostat
- T6A** - 6A fuse
- F** - Fuse (see table A)
- L** - Lead section (see table A)
- PG** - Minimum gas pressure switch
- PS** - Lock-out reset button
- VR** - Adjustment valve
- VS** - Safety valve
- VPS** - Seal control

The following table shows the supply lead sections and the type of fuse to be used.

Model	▼ RLS 68/M MX		▼ RLS 120/M MX		▼ RLS 160/M MX	
	230V	400V	230V	400V	230V	400V
F A	T16	T10	T16	T10	T25	T20
L mm <sup>2</sup>	2,5	1,5	2,5	1,5	2,5	2,5

Table A



▶ **“MODULATING” OPERATION – temperature probe**

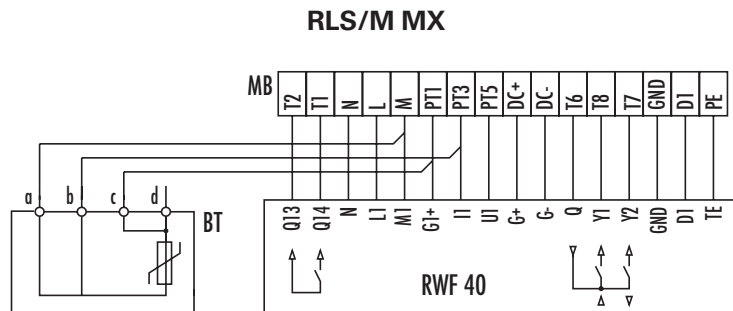

- MB** - Burner auxiliary terminal board
- S** - External lock-out signal
- IN** - Manual switch
- BT** - Temperature probe
- F** - Fuse (see table A)
- L** - Lead section (see table A)
- RWF40** - Regulator (installed on the burner)

▶ **“MODULATING” OPERATION – pressure probe**

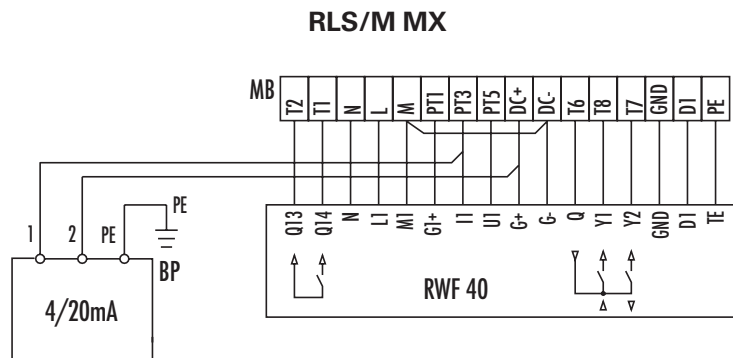

- MB** - Burner auxiliary terminal board
- S** - External lock-out signal
- IN** - Manual switch
- BP** - Pressure probe
- F** - Fuse (see table A)
- L** - Lead section (see table A)
- RWF40** - Regulator (installed on the burner)







## EMISSIONS

The emission data has been measured at maximum output, according to EN 676 and EN 267 standard. The NO<sub>x</sub> emissions of RLS/M MX burners are conforming to class 3 of EN 676 (gas) and Class 2 of EN 267 (oil).

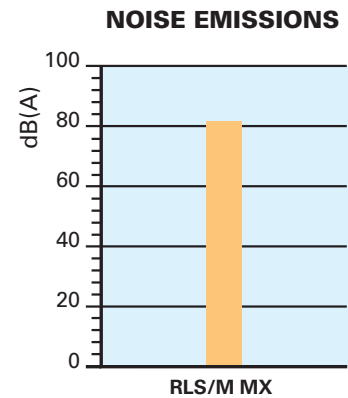
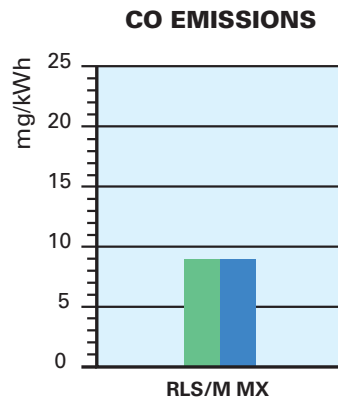
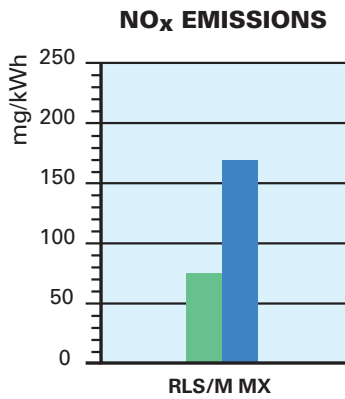

■ Gas working    ■ Light oil working

### Combustion head operating diagram of RLS/M MX model

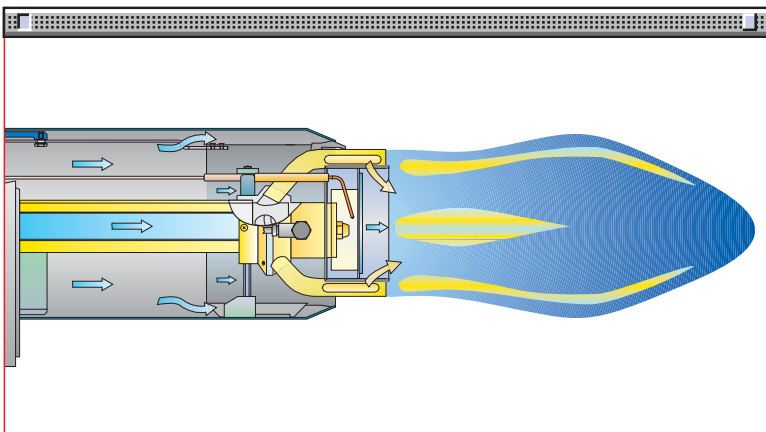

In the RLS/M MX burners part of the gas is distributed through outlets which are perpendicular to the air flow, while the remaining gas is injected directly into the centre of the flame.

This prevents no homogeneous concentrations in the flame with areas of high oxidation, producing very stable flame with gradual and progressive combustion as the flame develops, thus giving polluting emission values below even the most restrictive norm values.

## OVERALL DIMENSIONS (mm)



### BURNER

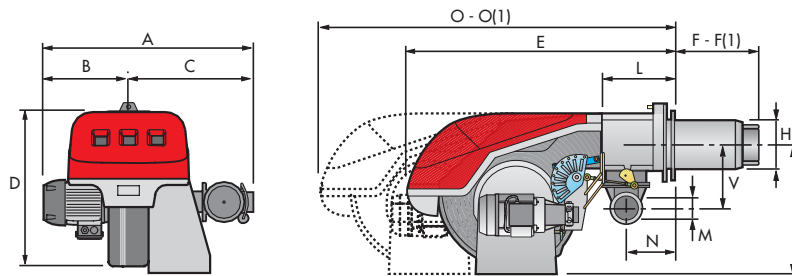

Model	A	B	C	D	E	F - F (1)	H	I	L	M	N	O - O (1)	V
▶ RLS 68/M MX	691	296	395	555	840	260 - 395	214	430	214	2"	134	1161 - 1300	221
▶ RLS 120/M MX	733	338	395	555	840	260 - 395	214	430	214	2"	134	1161 - 1300	221
▶ RLS 160/M MX	843	366	477	555	847	373 - 503	221	430	221	Rp2	141	1395 - 1535	186

(1) Length with extended combustion head.

### BURNER - BOILER MOUNTING FLANGE

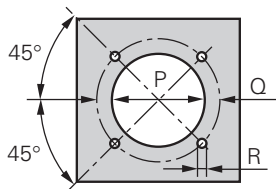

Model	P	Q	R
▶ RLS 68-120/M MX	195	275 - 325	M12
▶ RLS 160/M MX	230	325 - 368	M16

### PACKAGING

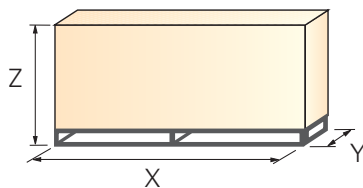

Model	X (1)	Y	Z	kg
▶ RLS 68/M MX	1400	975	645	70
▶ RLS 120/M MX	1400	975	645	76
▶ RLS 160/M MX	1400	975	645	95

(1) Length with standard and extended combustion head.



## INSTALLATION DESCRIPTION

Installation, start up and maintenance must be carried out by qualified and skilled personnel. All operations must be performed in accordance with the technical handbook supplied with the burner.

### BURNER SETTING

- ▶ All the burners have slide bars, for easier installation and maintenance.
- ▶ After drilling the boilerplate, using the supplied gasket as a template, dismantle the blast tube from the burner and fix it to the boiler.
- ▶ Adjust the combustion head.
- ▶ Fit the gas train choosing this on the basis of the maximum boiler output and following the diagrams included in the burner instruction handbook.
- ▶ Refit the burner casing to the slide bars.
- ▶ Install the nozzle choosing this on the basis of the maximum boiler output and following the diagrams included in the burner instruction handbook.
- ▶ Check the position of the electrodes.
- ▶ Close the burner, sliding it up to the flange, keeping it slightly raised to avoid the flame stability disk rubbing against the blast tube.

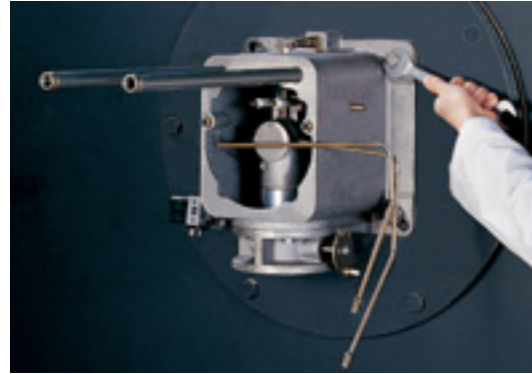

### ELECTRICAL AND HYDRAULIC CONNECTIONS AND START UP

- ▶ The burners are supplied for connection to two pipes fuel supply system.
- ▶ Connect the ends of the flexible pipes to the suction and return pipework using the supplied nipples.
- ▶ Make the electrical connections to the burner following the wiring diagrams included in the instruction handbook.
- ▶ Prime the pump by turning the motor (after checking rotation direction if it is a three phase motor).
- ▶ Adjust the gas train for first start.
- ▶ On start up, check:
  - Pressure pump and valve unit regulator (to max. and min.)
  - Gas pressure at the combustion head (to max. and min. output)
  - Combustion quality, in terms of unburned substances and excess air.

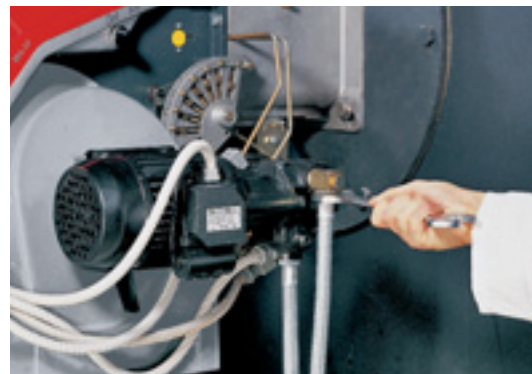

## BURNER ACCESSORIES



### Nozzles

The nozzles must be ordered separately. The following table shows the features and codes on the basis of the maximum required fuel output.



Nozzles type 60° B			
Burner	Rated delivery kg/h (*)	GPH	Nozzle code
RLS 68-120/M MX	21,2	5,00	<b>3042582</b>
	23,3	5,50	<b>3042202</b>
	25,5	6,00	<b>3042583</b>
	27,6	6,50	<b>3042222</b>
	29,7	7,00	<b>3042584</b>
	31,8	7,50	<b>3042242</b>
	33,9	8,00	<b>3042585</b>
	36,1	8,50	<b>3042262</b>
	38,2	9,00	<b>3042586</b>
	40,3	9,50	<b>3042282</b>
RLS/M MX	42,4	10,00	<b>3042292</b>
	46,7	11,00	<b>3042312</b>
	50,9	12,00	<b>3042322</b>
	55,1	13,00	<b>3042332</b>
	59,4	14,00	<b>3042352</b>
	63,6	15,00	<b>3042362</b>
	67,9	16,00	<b>3042382</b>
	72,1	17,00	<b>3042392</b>
	76,4	18,00	<b>3042412</b>
	80,6	19,00	<b>3042422</b>
RLS 160/M MX	84,8	20,00	<b>3042442</b>
	93,3	22,00	<b>3042462</b>
	101,8	24,00	<b>3042472</b>
RLS 160/M MX	110,3	26,00	<b>3042482</b>
	118,8	28,00	<b>3042492</b>

(\*) Nozzle rated delivery is referred to atomized pressure

### Spacer kit

If burner head penetration into the combustion chamber needs reducing, varying thickness spacers are available, as given in the following table:



Spacer kit		
Burner	Spacer thickness S (mm)	Kit code
RLS/M MX	110	3000722

### Continuous ventilation kit

If the burner requires continuous ventilation in the stages without flame, a special kit is available as given in the following table:



Continuous ventilation kit	
Burner	Kit code
RLS/M MX	3010094

### Accessories for modulating operation

To obtain modulating operation, the RLS 160/M MX series of burners requires a regulator with three point outlet controls. The following table lists the accessories for modulating operation with their application range.



Burner	Regulator type	Regulator code
RLS/M MX	RWF 40	3010212

The relative temperature or pressure probes fitted to the regulator must be chosen on the basis of the application.



Probe type	Range (°C) (bar)	Probe code
Temperature PT 100	-100 ÷ 500°C	3010110
Pressure 4 ÷ 20 mA	0 ÷ 2,5 bar	3010213
Pressure 4 ÷ 20 mA	0 ÷ 16 bar	3010214





Depending on the servomotor fitted to the burner, a three-pole potentiometer (1000 Ω) can be installed to check the position of the servomotor. The KITS available for the various burners are listed below.



Burner	Kit code
RLS/M MX	3010021

### Sound proofing box

If noise emission needs reducing even further, sound-proofing boxes are available, as given in the following table:



Sound proofing box			
Burner	Box type	Average noise reduction [dB(A)](*)	Box code
RLS 68-120/M MX	C1/3	10	3010403
RLS 160/M MX	C4/5	10	3010404

(\*) according to EN 15036-1 standard

### Extended head kit

“Standard head” burners can be transformed into “extended head” versions, by using the special kit. The kits available for the various burners, giving the original and the extended lengths, are listed below.

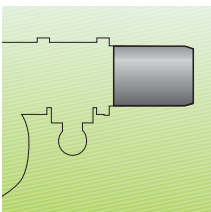

Extended head kit			
Burner	Standard head length (mm)	Extended head length (mm)	Kit code
RLS 68-120/M MX	260	395	3010360
RLS 160/M MX	373	503	3010340

## GAS TRAIN ACCESSORIES

### Adapters

When the diameter of the gas train is different from the set diameter of the burners, an adapter must be fitted between the gas train and the burner. The following table lists the adapters for various burners.

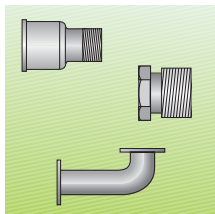

Adapters			
Burner	Gas train	Dimensions	Adapter code
RLS 120/M MX RLS 160/M MX	MBC 1900 SE 65 FC (CT*)	DN 65  2"1/2	1" 1/2 2" <b>3000825</b>
RLS 160/M MX	MBC 3100 SE 80 FC (CT*)	DN 80  2"1/2	2" <b>3000826</b>

\* with and without seal control

### Seal control kit

To test the valve seals on the gas train, a special "seal control kit" is available. The valve seal control device is compulsory (EN 676) on gas trains to burners with a maximum output over 1200 kW. The seal control is type VPS 504.



Seal control kit		
Burner	Gas train	Kit code
RLS/M MX	MBC 420	<b>3010123</b>
RLS/M MX	MBC 1200 SE 50 - MBC 1900 SE 65 FC - MBC 3100 SE 80 FC	<b>3010367</b>

### Stabiliser spring

Accessory springs are available to vary the pressure range of the gas train stabilisers. The following table shows these accessories with their application range.

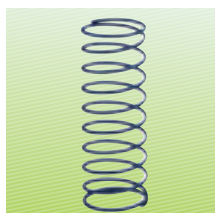

Stabiliser springs		
Gas train	Spring	Code
MBC 1900 SE 65 FC (CT)*	White from 4 to 20 mbar	<b>3010381</b>
	Red from 20 to 40 mbar	<b>3010382</b>
MBC 3100 SE 80 FC (CT)*	Black from 40 to 80 mbar	<b>3010383</b>
	Green from 80 to 150 mbar	<b>3010384</b>

\* with and without seal control

Please refer to the technical manual for the correct choice of spring.

## SPECIFICATION

A specific index guides your choice of burner from the various models available in the RLS/M MX series. Below is a clear and detailed specification description of the product.



### DESIGNATION OF SERIES

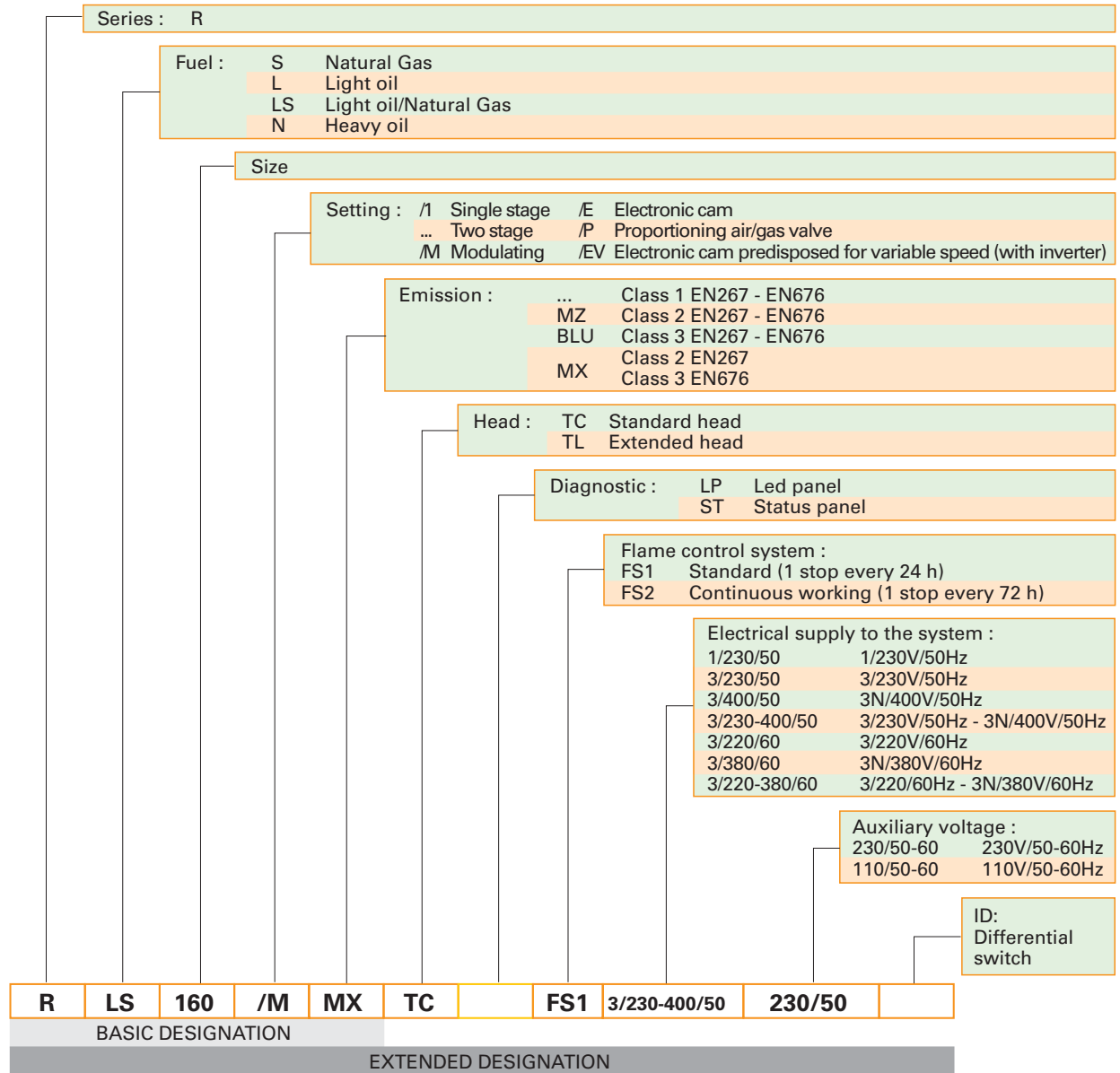

### AVAILABLE BURNER MODELS

RLS	68/M	MX	TC	FS1	3/230-400/50	230/50
RLS	68/M	MX	TL	FS1	3/230-400/50	230/50
RLS	68/M	MX	TC	FS2	3/230-400/50	230/50
RLS	68/M	MX	TL	FS2	3/230-400/50	230/50
RLS	120/M	MX	TC	FS1	3/230-400/50	230/50
RLS	120/M	MX	TL	FS1	3/230-400/50	230/50
RLS	120/M	MX	TC	FS2	3/230-400/50	230/50
RLS	120/M	MX	TL	FS2	3/230-400/50	230/50
RLS	160/M	MX	TC	FS1	3/230-400/50	230/50
RLS	160/M	MX	TL	FS1	3/230-400/50	230/50

Other versions are available on request.

## ▶ PRODUCT SPECIFICATION

### **Burner:**

Monoblock forced draught LOW NOx dual fuel burner with two stage operation at the oil side and two stage progressive or modulating operation at the gas side, with a specific kit, fully automatic, made up of:

- air suction circuit lined with sound-proofing material
- centrifugal fan with high performance and low sound emissions
- air damper for air flow setting and butterfly valve for regulating gas output controlled by a servomotor with variable cam
- starting motor at 2800 rpm, three-phase 400V with neutral, 50Hz
- low emission combustion head, that can be set on the basis of required output, fitted with:
  - stainless steel end cone, resistant to corrosion and high temperatures
  - ignition electrodes
  - gas distributor
  - flame stability disk
- maximum gas pressure switch to stop the burner in the case of excess pressure on the fuel supply line
- minimum air pressure switch stops the burner in case of insufficient air quantity at the combustion head
- gears pump for high pressure fuel supply
- pump starting motor
- oil safety valves
- two oil valves (1st and 2nd stage)
- flame control panel
- UV photocell for flame detection
- burner on/off selection switch
- manual or automatic output increase/decrease selection switch
- Oil/Gas selector
- flame inspection window
- slide bars for easier installation and maintenance
- protection filter against radio interference
- IP 44 electric protection level.

### **Gas train:**

Fuel supply line, 2" configuration:

- MULTIBLOC with integrated filter
- minimum gas pressure switch.

Fuel supply line DN 65 e DN80 configuration:

- filter
- MULTIBLOC
- minimum gas pressure switch.

### **Conforming to:**

- 89/336/EEC directive (electromagnetic compatibility)
- 73/23/EEC directive (low voltage)
- 92/42/EEC directive (performance)
- 90/396/EEC directive (gas)
- 98/37/EEC directive (machinery)
- EN 676 (gas burners)
- EN 267 (oil burners).

### **Standard equipment:**

- 1 gas train gasket
- 1 flange gasket
- 4 screws for fixing the flange
- 1 thermal screen
- 4 screws for fixing the burner flange to the boiler
- 2 flexible pipes for connection to the oil supply network
- 2 nipples for connection to the pump with gaskets
- Instruction handbook for installation, use and maintenance
- Spare parts catalogue.



**Available accessories to be ordered separately:**

- Nozzles
- Spacer kit
- Continuous ventilation kit
- RWF 40 output regulator
- Pressure probe 0 ÷ 2.4 bar
- Pressure probe 0 ÷ 16 bar
- Temperature probe -100 ÷ 500°C
- Potentiometer kit for the servomotor
- Gas train adapter
- Seal control kit
- Stabiliser spring
- Sound proofing box
- Extended head kit.





RIELLO S.p.A. - Via Ing. Pilade Riello, 5 - 37045 Legnago (VR) Italy  
Tel. ++39.0442630111 - Fax ++39.044221980

Internet: <http://www.rielloburners.com> - E-mail: [info@rielloburners.com](mailto:info@rielloburners.com)

Since the Company is constantly engaged in the production improvement, the aesthetic and dimensional features, the technical data, the equipment and the accessories can be changed.  
This document contains confidential and proprietary information of RIELLO S.p.A.  
Unless authorised, this information shall not be divulged, nor duplicated in whole or in part.

