

FITINGURI PPR – fără metal

Mufă egală PN 25

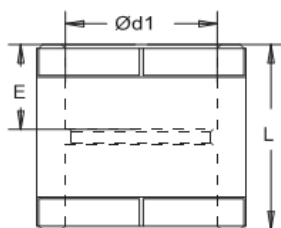

Cod	Dimensiune	Ød ₁	L	E	Greutate, kg
1H02000100	20 mm	19,5	34	14,5	0,010
1H02000101	25 mm	24,5	37	16	0,015
1H02000102	32 mm	31,5	41	18	0,026
1H02000103	40 mm	39,4	45	20,5	0,042
1H02000104	50 mm	49,4	52	23,5	0,082
1H02000105	63 mm	62,5	60	27,5	0,161
1H02000106	75 mm	74,2	65	31	0,207
1H02000107	90 mm	89,2	71	35,5	0,332
1H02000108	110 mm	109	79	41,5	0,640
1H02000109	125 mm	123,9	104	46,5	0,951

Mufă redusă INT-EXT PN 25

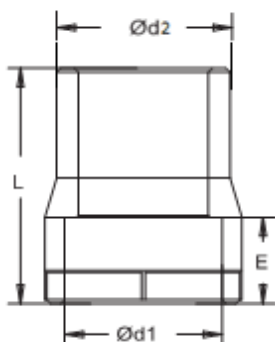

Cod	Dimensiune	Ød ₁	Ød ₂	L	E	Greutate, kg
1H02000110	25-20	19,5	25	39	14,5	0,013
1H02000111	32-20	19,5	32	39	14,5	0,015
1H02000112	32-25	24,5	32	43	16	0,018
1H02000113	40-20	19,5	40	39	14,5	0,030
1H02000114	40-25	24,5	40	43	16	0,027
1H02000115	40-32	31,5	40	48	18	0,032
1H02000116	50-20	19,5	50	43	14,5	
1H02000117	50-25	24,5	50	48	16	0,058
1H02000118	50-32	31,5	50	48	18	0,051
1H02000119	50-40	39,4	50	52	20,5	0,064
1H02000120	63-25	24,5	63		16	
1H02000121	63-32	31,5	63	48	18	0,102
1H02000122	63-40	39,4	63	52	20,5	0,090
1H02000123	63-50	49,4	63	60	23,5	0,093
1H02000124	75-40	39,4	75	52	20,5	0,154
1H02000125	75-50	49,4	75	60	23,5	0,135
1H02000126	75-63	62,5	75	67	27,5	0,166
1H02000127	90-50	49,4	90	60	23,5	0,277
1H02000128	90-63	62,5	90	67	27,5	0,242
1H02000129	90-75	74,2	90	72	31	0,280
1H02000130	110-63	62,5	110	67	27,5	0,426
1H02000131	110-75	74,2	110	72	31	0,380
1H02000132	110-90	89,2	110	90	35,5	0,453
1H02000133	125-90	89,2	125	120	35,5	0,800
1H02000134	125-110	109	125	120	41,5	0,901

Mufă redusă INT-INT PN 25

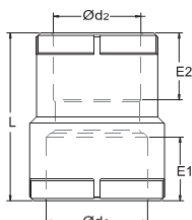

Cod	Dimensiune	Ød ₁	Ød ₂	L	E ₁	E ₂	Greutate, kg
1H02000135	25-20	24,5	19,5	39	16	14,5	0,013
1H02000136	32-20	31,5	19,5	39	18	14,5	0,018
1H02000137	32-25	31,5	24,5	43	18	16	0,021

Cot 90° PN 25

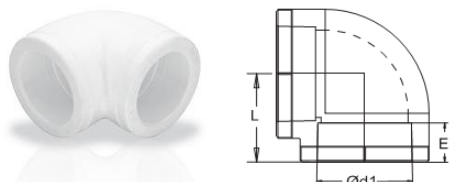

Cod	Dimensiune	Ød ₁	L	E	Greutate, kg
1H02000138	20 mm	19,5	23	14,5	0,015
1H02000139	25 mm	24,5	25	16	0,024
1H02000140	32 mm	31,5	28	18	0,042
1H02000141	40 mm	39,4	32	20,5	0,087
1H02000142	50 mm	49,4	37	23,5	0,140
1H02000143	63 mm	62,5	54	27,5	0,280
1H02000144	75 mm	74,2	60	31	0,435
1H02000145	90 mm	89,2	76	35,5	0,760
1H02000146	110 mm	109	94	41,5	1,316
1H02000147	125 mm	123,9	110	46,5	2,052

Cot 90° interior - exterior PN 25

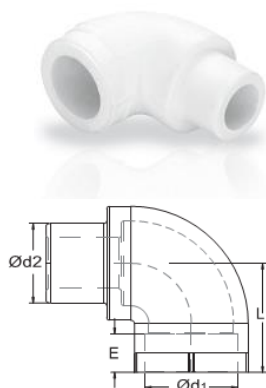

Cod	Dimensiune	Ød ₁	Ød ₂	L	E	Greutate, kg
1H02000148	20 mm	19,5	20,3	23	14,5	0,020
1H02000149	25 mm	24,5	25,3	25	16	0,029
1H02000150	32 mm	31,5	32,3	28	18	0,053

Cot 90° redus PN 25

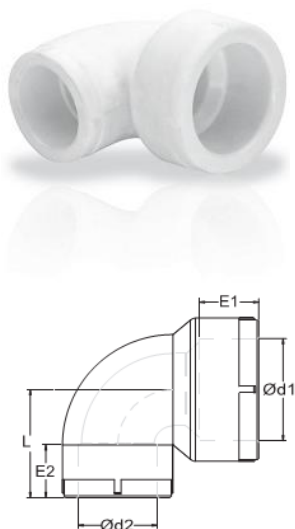

Cod	Dimensiune	Ød ₁	Ød ₂	L	E ₁	E ₂	Greutate, kg
1H02000151	25-20	24,5	19,5	39	16	14,5	0,019
1H02000153	32-25	31,5	24,5	39	18	16	0,034

Curbă 45° interior – interior PN 25

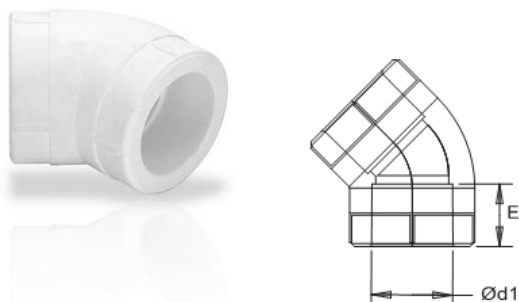

Cod	Dimensiune	Ød ₁	E	Greutate, kg
1H02000154	20 mm	19,5	14,5	0,011
1H02000155	25 mm	24,5	16	0,019
1H02000156	32 mm	31,5	18	0,040
1H02000157	40 mm	39,4	20,5	0,058
1H02000158	50 mm	49,4	23,5	0,101
1H02000159	63 mm	62,5	27,5	0,203
1H02000160	75 mm	74,2	31	0,329
1H02000161	90 mm	89,2	35,5	0,520
1H02000162	110 mm	109	41,5	0,950

Curbă 45° interior – exterior PN 25

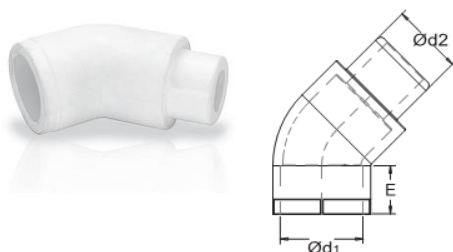

Cod	Dimensiune	Ød ₁	Ød ₂	E	Greutate, kg
1H02000163	20 mm	19,5	20,3	14,5	0,025
1H02000164	25 mm	24,5	25,3	16	0,037
1H02000165	32 mm	31,5	32,3	18	0,055

Teu egal PN 25



Cod	Dimensiune	Ød ₁	L	E	Greutate, kg
1H02000166	20 mm	19,5	52	14,5	0,020
1H02000167	25 mm	24,5	59	16	0,031
1H02000168	32 mm	31,5	70	18	0,060
1H02000169	40 mm	39,4	82	20,5	0,112
1H02000170	50 mm	49,4	100	23,5	0,185
1H02000171	63 mm	62,5	120	27,5	0,365
1H02000172	75 mm	74,2	137	31	0,532
1H02000173	90 mm	89,2	160	35,5	0,910
1H02000174	110 mm	109	190	41,5	1,510
1H02000175	125 mm	123,9	221	46,5	2,465

Teu dublu PN 25

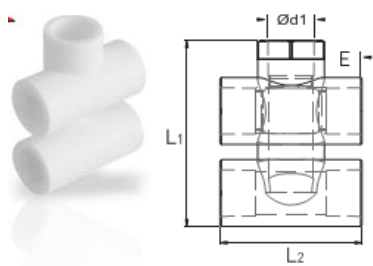

Cod	Dimensiune	Ød ₁	E	L ₁	L ₂	Greutate, kg
1H02000218	20 mm	19,5	14,5	78,3	60	0,044
1H02000219	25 mm	24,5	16	93	70	0,067

Teu redus PN 25

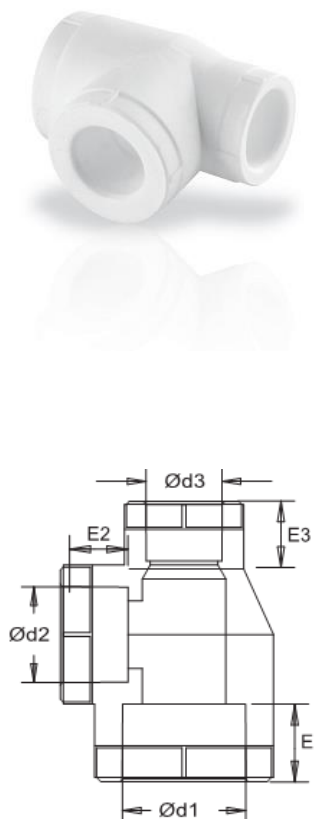

Cod	Dimensiune	Ød ₁	E ₁	Ød ₂	E ₂	Ød ₃	E ₃	Greutate, kg
1H02000176	20-25-20	19,5	14,5	24,5	16	19,5	14,5	0,031
1H02000177	25-20-20	24,5	16	19,5	14,5	19,5	14,5	0,031
1H02000178	25-20-25	24,5	16	19,5	14,5	24,5	16	0,027
1H02000179	25-25-20	24,5	16	24,5	16	19,5	14,5	0,028
1H02000180	32-20-20	31,5	18	19,5	14,5	19,5	14,5	0,050
1H02000181	32-20-25	31,5	18	19,5	14,5	24,5	16	0,046
1H02000182	32-20-32	31,5	18	19,5	14,5	31,5	18	0,049
1H02000183	32-25-20	31,5	18	24,5	16	19,5	14,5	0,048
1H02000184	32-25-25	31,5	18	24,5	16	24,5	16	0,044
1H02000185	32-25-32	31,5	18	24,5	16	31,5	18	0,047
1H02000186	40-20-40	39,4	20,5	19,5	14,5	39,4	20,5	0,098
1H02000187	40-25-40	39,4	20,5	24,5	16	39,4	20,5	0,094
1H02000188	40-32-40	39,4	20,5	31,5	18	39,4	20,5	0,122
1H02000189	50-20-50	49,4	23,5	19,5	14,5	49,4	23,5	0,159
1H02000190	50-25-50	49,4	23,5	24,5	16	49,4	23,5	0,155
1H02000191	50-32-50	49,4	23,5	31,5	18	49,4	23,5	0,153
1H02000192	50-40-50	49,4	23,5	39,4	20,5	49,4	23,5	0,203
1H02000193	63-20-63	62,5	27,5	19,5	14,5	62,5	27,5	0,253
1H02000194	63-25-63	62,5	27,5	24,5	16	62,5	27,5	0,263
1H02000195	63-32-63	62,5	27,5	31,5	18	62,5	27,5	0,266
1H02000196	63-40-63	62,5	27,5	39,4	20,5	62,5	27,5	0,264
1H02000197	63-50-63	62,5	27,5	49,4	23,5	62,5	27,5	0,408
1H02000198	75-20-75	74,2	31	19,5	14,5	74,2	31	0,600
1H02000199	75-25-75	74,2	31	24,5	16	74,2	31	0,600
1H02000200	75-32-75	74,2	31	31,5	18	74,2	31	0,496
1H02000201	75-40-75	74,2	31	39,4	20,5	74,2	31	0,497
1H02000202	75-50-75	74,2	31	49,4	23,5	74,2	31	0,505
1H02000203	75-63-75	74,2	31	62,5	27,5	74,2	31	0,513
1H02000204	90-25-90	89,2	35,5	24,5	16	89,2	35,5	1,060
1H02000205	90-32-90	89,2	35,5	31,5	18	89,2	35,5	1,060
1H02000206	90-40-90	89,2	35,5	39,4	20,5	89,2	35,5	0,849
1H02000207	90-50-90	89,2	35,5	49,4	23,5	89,2	35,5	0,860
1H02000208	90-63-90	89,2	35,5	62,5	27,5	89,2	35,5	0,853
1H02000209	90-75-90	89,2	35,5	74,2	31	89,2	35,5	0,873
1H02000210	110-32-110	109	41,5	31,5	18	109	41,5	1,440
1H02000211	110-40-110	109	41,5	39,4	20,5	109	41,5	1,440
1H02000212	110-50-110	109	41,5	49,4	23,5	109	41,5	1,465
1H02000213	110-63-110	109	41,5	62,5	27,5	109	41,5	1,460
1H02000214	110-75-110	109	41,5	74,2	31	109	41,5	1,465
1H02000215	110-90-110	109	41,5	89,2	35,5	109	41,5	1,460
1H02000216	125-90-125	123,9	46,5	89,2	35,5	123,9	46,5	
1H02000217	125-110-125	123,9	46,5	109	41,5	123,9	46,5	

Ocolire PN 25

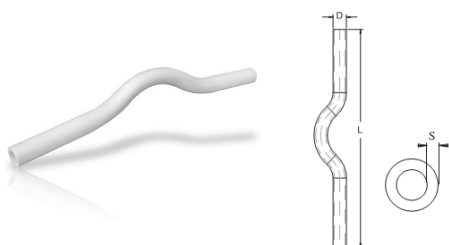

Cod	Dimensiune	S	D	L	Greutate, kg
1H02000220	20 mm	3,4	20,3	350	0,059
1H02000221	25 mm	4,2	25,3	350	0,093
1H02000222	32 mm	5,4	32,3	350	0,152
1H02000223	40 mm	6,7	40,4	350	0,242

Ocolire tip C PN 25

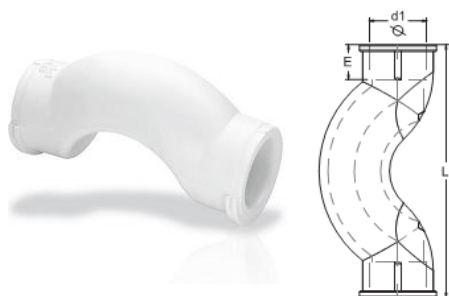

Cod	Dimensiune	Ød ₁	E	L	Greutate, kg
1H02000224	20 mm	19,5	14,5	86	0,025
1H02000225	25 mm	24,5	16	95	0,039
1H02000226	32 mm	31,5	18	117	0,081

Ocolire cu mufă PN 25

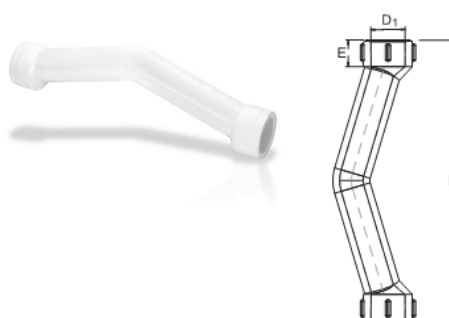

Cod	Dimensiune	D ₁	E	L	Greutate, kg
1H02000227	20 mm	19,5	14,5	162	0,024
1H02000228	25 mm	24,5	16	200	0,037
1H02000229	32 mm	31,5	18	240	0,062

Cruce egală PN 25

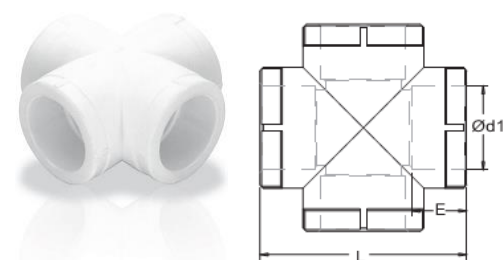

Cod	Dimensiune	Ød ₁	E	L	Greutate, kg
1H02000232	20 mm	19,5	14,5	50	0,024
1H02000233	25 mm	24,5	16	55	0,037
1H02000234	32 mm	31,5	18	60	0,062
1H02000235	40 mm	39,4	20,5	86	0,103

Cruce redusă PN 25

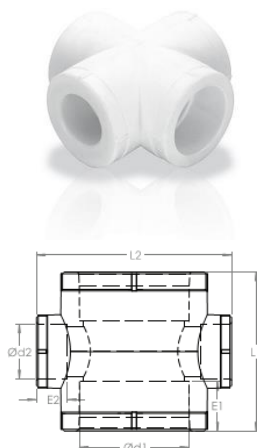

Cod	Dimensiune	Ød ₁	Ød ₂	E ₁	E ₂	L ₁	L ₂	Greutate, kg
1H02000236	25 - 20	24,5	19,5	16,5	14,5	56	56	0,024
1H02000237	32 - 25	31,5	24,5	18	16,5	70	70	0,075
1H02000238	40 - 32	39,4	31,5	20,5	18	86	86	0,063
1H02000239	50 - 20	49,4	19,5	23,5	14,5	84	95	
1H02000240	50 - 25	49,4	24,5	23,5	16	84	95	
1H02000241	50 - 32	49,4	31,5	23,5	18	114	95	
1H02000242	50 - 40	49,4	39,4	23,5	20,5	114	95	
1H02000243	63 - 20	62,5	19,5	27,5	14,5	91	111	
1H02000244	63 - 25	62,5	24,5	27,5	16	91	111	
1H02000245	63 - 32	62,5	31,5	27,5	18	127	113	
1H02000246	63 - 40	62,5	39,4	27,5	20,5	127	113	

Cruce teu PN 25

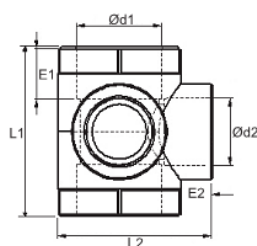

Cod	Dimensiune	Ød ₁	Ød ₂	E ₁	E ₂	L ₁	L ₂	Greutate, kg
1H02000247	32 - 20	31,5	19,5	18	14,5	62	57	0,055
1H02000248	32 - 25	31,5	24,5	18	16,5	62	57	0,051
1H02000249	40 - 20	39,4	19,5	20,5	14,5	66	60	0,087
1H02000250	40 - 25	39,4	24,5	20,5	16,5	66	60	0,063

Liră de dilatație PN 25

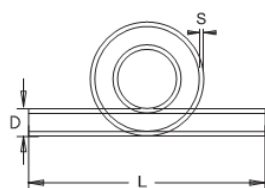

Cod	Dimensiune	S	D	L	Greutate, kg
1H02000251	20 mm	3,4	20,3	350	0,105
1H02000252	25 mm	4,2	25,3	350	0,199
1H02000253	32 mm	5,4	32,3	350	0,375
1H02000254	40 mm	6,7	40,4	350	0,632

Capac PN 25

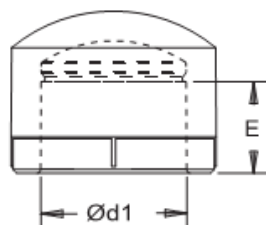

Cod	Dimensiune	Ød ₁	E	Greutate, kg
1H02000255	20 mm	19,5	14,5	0,009
1H02000256	25 mm	24,5	16	0,013
1H02000257	32 mm	31,5	18	0,025
1H02000258	40 mm	39,4	20,5	0,037
1H02000259	50 mm	49,4	23,5	0,078
1H02000260	63 mm	62,5	27,5	0,125
1H02000261	75 mm	74,2	31	0,211
1H02000262	90 mm	89,2	35,5	0,337
1H02000263	110 mm	109	41,5	0,566
1H02000264	125 mm	123,9	46,5	0,951

Dop de probă PN 25

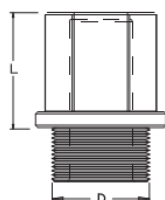

Cod	Dimensiune	D	L	Greutate, kg
1H02000265	1/2"	20	25	0,009
1H02000266	3/4"	25	15	0,007

Dop lung de probă PN 25

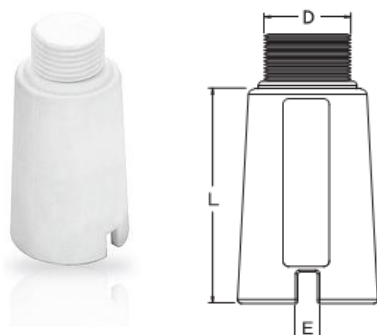

Cod	Dimensiune	D	L	E	Greutate, kg
1H02000268	1/2"	21	56	5	0,017