

FITINGURI PPR CU METAL

Racord drept cu filet metalic interior PN 25

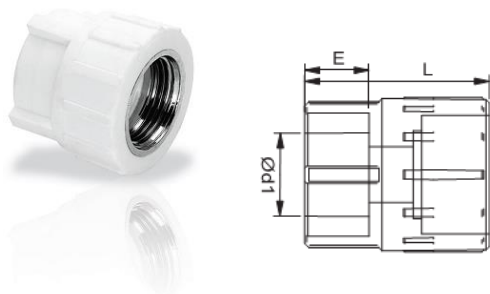

Cod	Dimensiune	Ød ₁	L	E	Greutate, kg
1H02000500	20 - 1/2	19,5	40	14,5	0,049
1H02000501	20 - 3/4	19,5	40	14,5	0,049
1H02000502	25 - 1/2	24,5	42	16	0,052
1H02000503	25 - 3/4	24,5	42	16	0,053
1H02000504	25 - 1	24,5	42	16	0,098
1H02000505	32 - 1/2	31,5	44	18	0,081
1H02000506	32 - 3/4	31,5	44	18	0,081
1H02000507	32 - 1	31,5	44	18	0,088

Racord drept hexagonal cu filet metalic interior PN 25

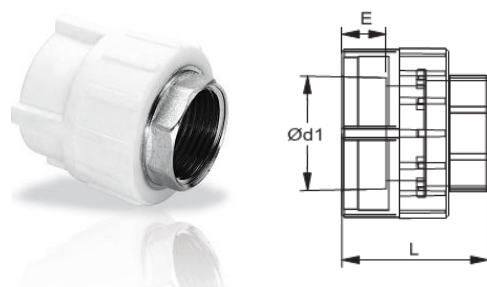

Cod	Dimensiune	Ød ₁	L	E	Greutate, kg
1H02000514	32 - 1	31,5	55	18	0,110
1H02000515	40 - 1	39,4	60	20,5	0,148
1H02000516	40 - 1 1/4	39,4	65	20,5	0,176
1H02000517	50 - 1 1/2	49,4	70	23,5	0,258
1H02000518	63 - 2	62,5	75	27,5	0,367
1H02000519	75 - 2 1/2	74,2	80	31	0,891
1H02000520	90 - 3	89,2	105	35,5	0,966
1H02000521	110 - 4	109	110	41,5	1,638
1H02000522	125 - 5	123,9	130	46,5	2,785

Racord drept cu filet metalic exterior PN 25

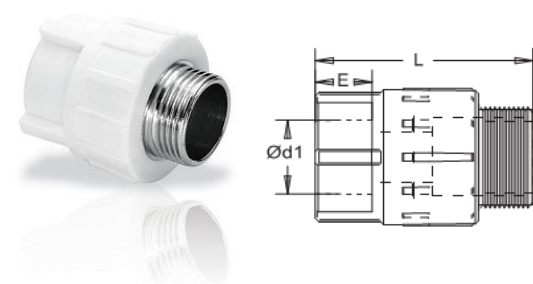

Cod	Dimensiune	Ød ₁	L	E	Greutate, kg
1H02000524	20 - 1/2	19,5	55	14,5	0,048
1H02000525	20 - 3/4	19,5	55	14,5	0,070
1H02000526	25 - 1/2	24,5	57	16	0,059
1H02000527	25 - 3/4	24,5	57	16	0,068
1H02000528	25 - 1	24,5	57	16	0,078
1H02000529	32 - 1/2	31,5	60	18	0,095
1H02000530	32 - 3/4	31,5	60	18	0,097
1H02000531	32 - 1	31,5	60	18	0,111

Racord drept hexagonal cu filet metalic exterior PN 25

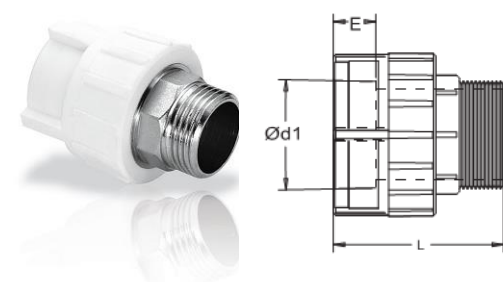

Cod	Dimensiune	Ød ₁	L	E	Greutate, kg
1H02000538	32 - 1	31,5	59	18	0,148
1H02000539	40 - 1	39,4	75	20,5	0,186
1H02000540	40 - 1 1/4	39,4	80	20,5	0,214
1H02000541	50 - 1 1/2	49,4	90	23,5	0,326
1H02000542	63 - 2	62,5	95	27,5	0,565
1H02000543	75 - 2 1/2	74,2	105	31	0,782
1H02000544	90 - 3	89,2	120	35,5	1,151
1H02000545	110 - 4	109	140	41,5	1,810
1H02000546	125 - 5	123,9	130	46,5	2,842

Racord cu semiolandez PN 25

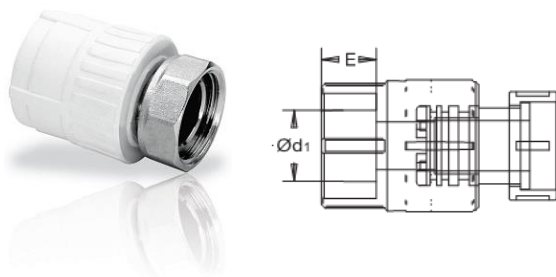

Cod	Dimensiune	Ød ₁	E	Greutate, kg
1H02000547	20 - 1/2	19,5	14,5	0,045
1H02000548	20 - 3/4	19,5	14,5	0,066
1H02000549	25 - 1/2	24,5	16	0,054
1H02000550	25 - 3/4	24,5	16	0,062
1H02000551	25 - 1	24,5	16	0,099
1H02000552	32 - 3/4	31,5	18	0,082
1H02000553	32 - 1	31,5	18	0,124
1H02000554	32 - 1 1/4	31,5	18	0,166

Racord cu mufă PN 25

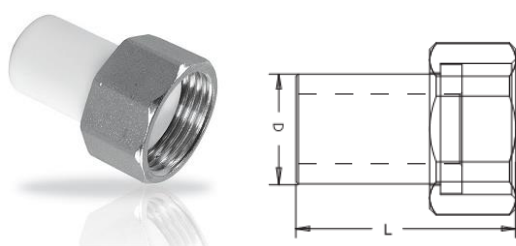

Cod	Dimensiune	Ød ₁	L	Greutate, kg
1H02000555	20 - 3/4	20,3	38	0,042
1H02000556	25 - 1	25,3	43	0,063

Racord cu niplu PN 25

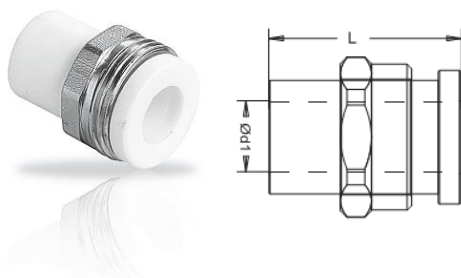

Cod	Dimensiune	Ød ₁	L	Greutate, kg
1H02000557	20 - 3/4	20,3	38	0,026
1H02000558	25 - 1	25,3	43	0,048

Racord cu olandez filet interior PN 25

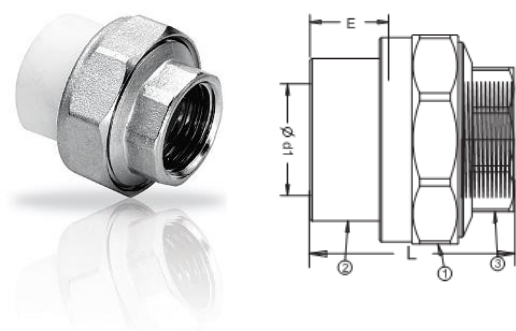

Cod	Dimensiune	Ød ₁	L	E	Greutate, kg
1H02000569	20 - 1/2	19,5	38	14,5	0,066
1H02000570	20 - 3/4	19,5	38	14,5	0,074
1H02000571	20 - 1	19,5	39	14,5	0,083
1H02000572	25 - 1/2	24,5	37	16	0,098
1H02000573	25 - 3/4	24,5	38	16	0,094
1H02000574	25 - 1	24,5	40	16	0,107
1H02000575	32 - 1/2	31,5	42	16	0,127
1H02000576	32 - 3/4	31,5	42	16	0,133
1H02000577	32 - 1	31,5	42	16	0,133
1H02000578	32 - 1 1/4	31,5	46	16	0,139
1H02000579	40 - 1 1/4	39,4	48	20,5	0,210
1H02000580	50 - 1 1/2	49,4	48	23,5	0,353
1H02000581	63 - 2	62,5	58	27,5	0,581

Racord cu olandez filet exterior PN 25

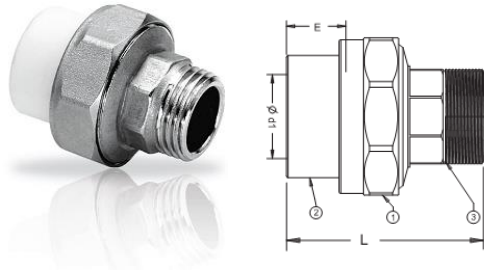

Cod	Dimensiune	Ød ₁	L	E	Greutate, kg
1H02000582	20 - 1/2	19,5	45	14,5	0,071
1H02000583	20 - 3/4	19,5	45	14,5	0,085
1H02000584	20 - 1	19,5	50	14,5	0,100
1H02000585	25 - 1/2	24,5	46	16	0,100
1H02000586	25 - 3/4	24,5	49	16	0,111
1H02000587	25 - 1	24,5	50	16	0,127
1H02000588	32 - 1/2	31,5	49	16	0,138
1H02000589	32 - 3/4	31,5	49	16	0,134
1H02000590	32 - 1	31,5	52	16	0,146
1H02000591	32 - 1 1/4	31,5	56	16	0,198
1H02000592	40 - 1 1/4	39,4	59	20,5	0,241
1H02000593	50 - 1 1/2	49,4	62	23,5	0,384
1H02000594	63 - 2	62,5	72	27,5	0,671

Racord dublu cu olandez complet

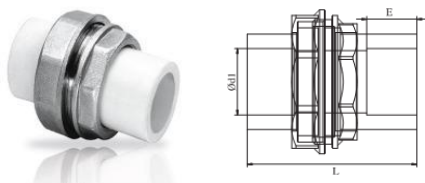

Cod	Dimensiune	Ød ₁	L	E	Greutate, kg
1H02000595	20 mm	19,5	14,5	56	0,088
1H02000596	25 mm	24,5	16	59	0,138
1H02000597	32 mm	31,5	18	60	0,169
1H02000598	40 mm	39,4	20,5	59	0,229
1H02000599	50 mm	49,4	23,5	59	0,364
1H02000600	63 mm	62,5	27,5	72	0,612

Cot 90° cu filet metalic interior PN 25

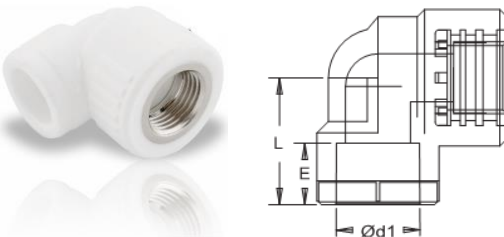

Cod	Dimensiune	Ød ₁	L	E	Greutate, kg
1H02000601	20 - 1/2	19,5	35	14,5	0,052
1H02000602	20 - 3/4	19,5	35	14,5	0,072
1H02000603	25 - 1/2	24,5	40	16	0,059
1H02000604	25 - 3/4	24,5	40	16	0,069
1H02000605	32 - 1/2	31,5	45	18	0,09
1H02000606	32 - 3/4	31,5	45	18	0,091
1H02000607	32 - 1	31,5	45	18	0,125

Cot hexagonal 90° cu filet metalic interior PN 25

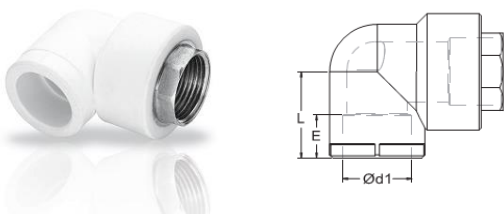

Cod	Dimensiune	Ød ₁	L	E	Greutate, kg
1H02000608	32 - 1	31,5	38,5	18	0,140
1H02000609	40 - 1 1/4	39,4	48,5	20,5	0,291

Cot 90° cu filet metalic exterior PN 25

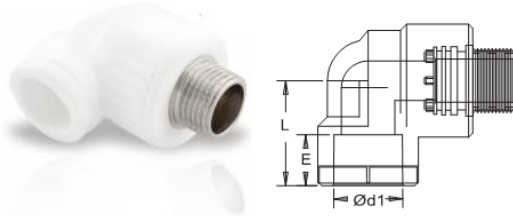

Cod	Dimensiune	Ød ₁	L	E	Greutate, kg
1H02000610	20 - 1/2	19,5	35	14,5	0,059
1H02000611	20 - 3/4	19,5	35	14,5	0,070
1H02000612	25 - 1/2	24,5	40	16	0,067
1H02000613	25 - 3/4	24,5	40	16	0,083
1H02000614	32 - 1/2	31,5	45	18	0,097
1H02000615	32 - 3/4	31,5	45	18	0,103
1H02000616	32 - 1	31,5	45	18	0,148

Cot hexagonal cu filet metalic exterior PN

25

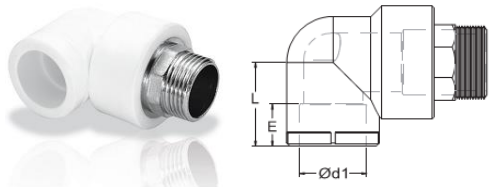

Cod	Dimensiune	Ød ₁	L	E	Greutate, kg
1H02000617	32 - 1	31,5	38,5	18	0,191
1H02000618	40 - 1 1/4	39,4	48,5	20,5	0,278

Cot 90° cu semiolandez

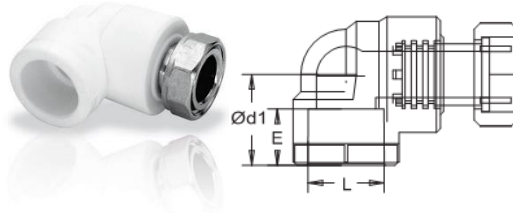

Cod	Dimensiune	Ød ₁	L	E	Greutate, kg
1H02000619	20 - 1/2	19,5	30	14,5	0,054
1H02000620	20 - 3/4	19,5	30	14,5	0,085
1H02000621	25 - 3/4	24,5	32	16	0,080
1H02000622	25 - 1	24,5	32	16	0,098
1H02000623	32 - 3/4	31,5	38	18	0,103
1H02000624	32 - 1 1/4	31,5	38	18	0,125
1H02000625	32 - 1	31,5	38	18	0,189

Cot 90° cu olandez cu filet exterior pentru radiator

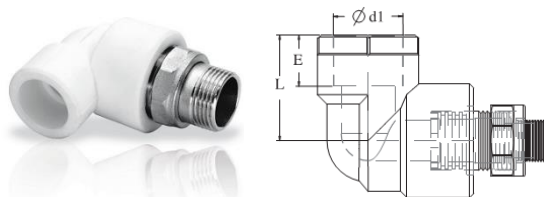

Cod	Dimensiune	Ød ₁	L	E	Greutate, kg
1H02000626	20 - 1/2	19,5	30	14,5	0,126
1H02000627	20 - 3/4	19,5	35	14,5	0,131
1H02000628	25 - 1/2	24,5	40	18	0,121
1H02000629	25 - 3/4	24,5	40	18	0,131

Racord drept cu olandez cu filet exterior pentru radiator

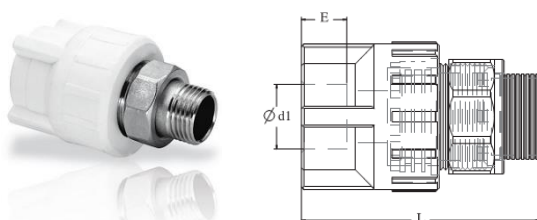

Cod	Dimensiune	Ød ₁	L	E	Greutate, kg
1H02000630	20 - 1/2	19,5	55	14,5	0,118
1H02000631	20 - 3/4	19,5	57	14,5	0,130
1H02000632	25 - 1/2	24,5	57	16	0,116
1H02000633	25 - 3/4	24,5	57	16	0,128

Cot suport perete cu filet interior

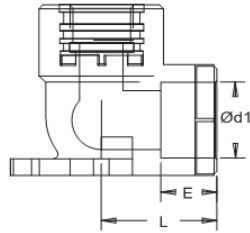

Cod	Dimensiune	Ød ₁	L	E	Greutate, kg
1H02000634	20 - 1/2	19,5	30	14,5	0,061
1H02000635	25 - 1/2	24,5	33	16	0,071

Cot suport perete cu filet exterior

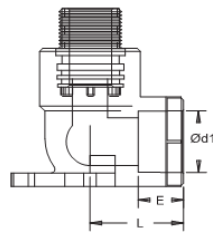

Cod	Dimensiune	Ød ₁	L	E	Greutate, kg
1H02000637	20 - 1/2	19,5	30	14,5	0,070
1H02000638	25 - 1/2	24,5	33	16	0,081

Cot cu prindere pe perete dublu special filet interior

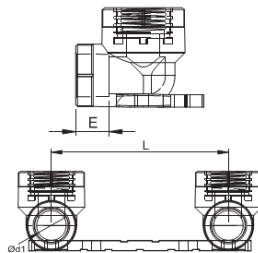

Cod	Dimensiune	Ød ₁	L	E	Greutate, kg
1H02000639	20 - 1/2	19,5	150	14,5	0,159
1H02000640	20 - 3/4	19,5	150	14,5	0,205
1H02000641	25 - 1/2	24,5	150	16	0,149
1H02000642	25 - 3/4	24,5	150	16	0,169

Cot cu prindere pe perete dublu special filet exterior

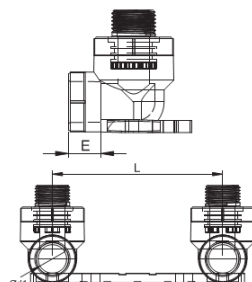

Cod	Dimensiune	Ød ₁	L	E	Greutate, kg
1H02000643	20 - 1/2	19,5	150	14,5	0,151
1H02000644	20 - 3/4	19,5	150	14,5	0,194
1H02000645	25 - 1/2	24,5	150	16	0,162
1H02000646	25 - 3/4	24,5	150	16	0,168

Cot baterie bideu dublu special cu prindere pe perete filet interior

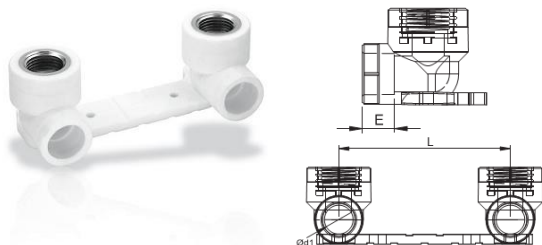

Cod	Dimensiune	Ød ₁	L	E	Greutate, kg
1H02000653	20 - 1/2	19,5	100	14,5	0,111
1H02000654	25 - 1/2	24,5	100	16	0,141
1H02000655	25 - 3/4	24,5	100	16	0,135

Cot baterie bideu dublu special cu prindere pe perete filet exterior

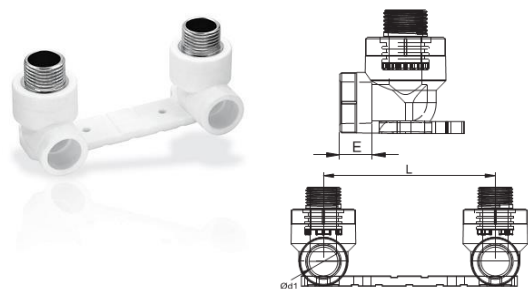

Cod	Dimensiune	Ød ₁	L	E	Greutate, kg
1H02000656	20 - 1/2	19,5	100	14,5	
1H02000657	20 - 3/4	19,5	100	14,5	
1H02000658	25 - 1/2	24,5	100	16	
1H02000659	25 - 3/4	24,5	100	18	

Cot cu prindere de perete dublu special filet interior

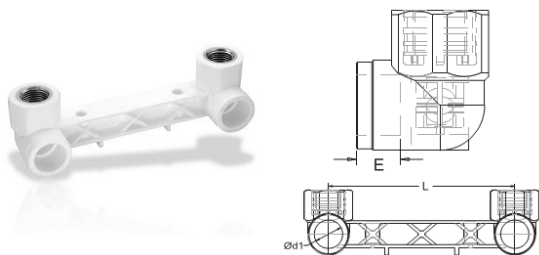

Cod	Dimensiune	Ød ₁	L	E	Greutate, kg
1H02000660	20 - 1/2	19,5	150	14,5	0,134
1H02000661	25 - 1/2	24,5	150	16	0,136

Cot cu prindere de perete dublu special filet exterior

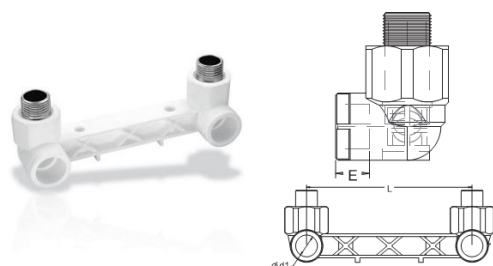

Cod	Dimensiune	Ød ₁	L	E	Greutate, kg
1H02000656	20 - 1/2	19,5	150	14,5	0,151
1H02000657	20 - 3/4	19,5	150	14,5	0,194
1H02000658	25 - 1/2	24,5	150	16	0,162
1H02000659	25 - 3/4	24,5	150	18	0,168

Cot dublu cu prindere pe perete filet interior

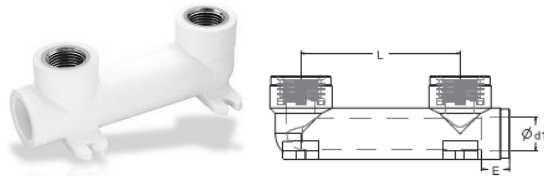

Cod	Dimensiune	Ød ₁	L	E	Greutate, kg
1H02000660	20 - 1/2	19,5	90	14,5	0,125
1H02000661	25 - 1/2	24,5	90	16	0,135

Teu cu filet metalic interior

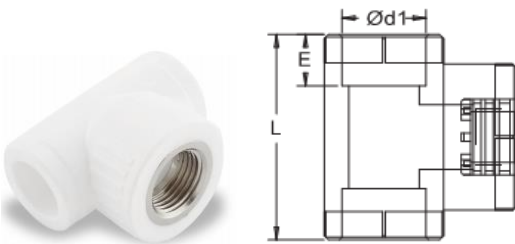

Cod	Dimensiune	Ød ₁	L	E	Greutate, kg
1H02000661	20 - 1/2	19,5	60	14,5	0,055
1H02000662	20 - 3/4	19,5	60	14,5	0,084
1H02000663	25 - 1/2	24,5	52	16	0,061
1H02000664	25 - 3/4	24,5	66	16	0,076
1H02000665	32 - 1/2	31,5	80	18	0,102
1H02000666	32 - 3/4	31,5	80	18	0,103
1H02000667	32 - 1	31,5	80	18	0,134
1H02000669	40 - 1/2	39,4	77	20,5	0,117
1H02000670	40 - 3/4	39,4	77	20,5	0,151
1H02000671	40 - 1	39,4	82	20,5	0,175
1H02000672	50 - 1/2	49,4	87	23,5	0,183
1H02000673	50 - 3/4	49,4	87	23,5	0,185
1H02000674	50 - 1	49,4	102	23,5	0,241
1H02000675	63 - 1/2	62,5	120	27,5	0,274
1H02000676	63 - 3/4	62,5	120	27,5	0,291
1H02000677	63 - 1	62,5	120	27,5	0,378

Teu hexagonal cu filet metalic interior

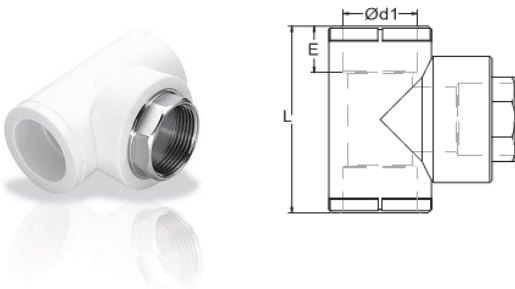

Cod	Dimensiune	Ød ₁	L	E	Greutate, kg
1H02000678	32 - 1	31,5	80	18	0,156
1H02000679	40 - 1 1/4	39,4	97,5	20,5	0,303

Teu cu filet metalic exterior

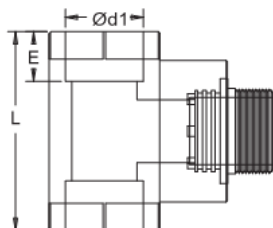

Cod	Dimensiune	Ød ₁	L	E	Greutate, kg
1H02000680	20 - 1/2	19,5	52	14,5	0,062
1H02000681	20 - 3/4	19,5	52	14,5	0,065
1H02000682	25 - 1/2	24,5	59	16	0,072
1H02000683	25 - 3/4	24,5	59	16	0,088
1H02000684	32 - 1/2	31,5	70	18	0,109
1H02000685	32 - 3/4	31,5	44	18	0,116
1H02000686	32 - 1	31,5	44	18	0,161
1H02000687	40 - 1/2	39,4	77	20,5	0,121
1H02000688	40 - 3/4	39,4	77	20,5	0,156
1H02000689	40 - 1	39,4	82	20,5	0,180
1H02000690	50 - 1/2	49,4	87	23,5	0,188
1H02000691	50 - 3/4	49,4	87	23,5	0,191
1H02000692	50 - 1	49,4	102	23,5	0,248
1H02000693	63 - 1/2	62,5	120	27,5	0,281
1H02000694	63 - 3/4	62,5	120	27,5	0,300
1H02000695	63 - 1	62,5	120	27,5	0,389

Teu hexagonal cu filet metalic exterior

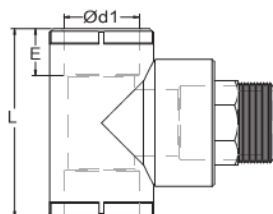

Cod	Dimensiune	Ød ₁	L	E	Greutate, kg
1H02000696	32 - 1	31,5	70	18	0,191
1H02000697	40 - 1 1/4	39,4	97,5	20,5	0,301

Teu cu semiolandez

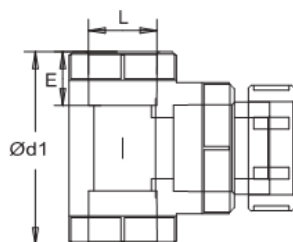

Cod	Dimensiune	Ød ₁	L	E	Greutate, kg
1H02000698	20 - 1/2	19,5	30	14,5	0,053
1H02000699	20 - 3/4	19,5	30	14,5	0,084
1H02000700	25 - 3/4	24,5	32	16	0,081
1H02000701	25 - 1	24,5	32	16	0,143
1H02000702	32 - 1	31,5	38	18	0,129
1H02000703	32 - 1 1/4	31,5	38	18	0,171